



BRIDGEPOINT
SYSTEMS

200,000 BTU Service Manual



thermal energy system



Bridgepoint Systems
4282 South 590 West
Salt Lake City, UT 84123
801-261-1282 | 801-268-3856 fax

“TES - World’s Fastest Drying System”™

Table of Contents

Introduction	3
General Information	4
SECTION 1	
Propane Safety	6
Propane Vaporization	8
Heater Operation Safety	9
SECTION 2	
Heater Operation	12
Troubleshooting	16
Flow Path	21
Wiring Diagrams	24
SECTION 3	
Maintenance & Service	29
• Propane Gas Pressure Adjustment	29
• Adjusting Pilot Flame	30
• Burner Jet Replacement	31
• Main gas Valve Replacement	32
• Combustion Chamber Inspection	32
• Heat Exchanger Inspection	33
• Vent System	33
• Propane Leaks	33
• Controls	34
• Expansion Tank	35
• Solution Pump	35
• System Pressure Pump	36
• Pressure Reducing Valve	38
• Fluid Filtering	40
• Wheels	41
• Maintenance Log	42
Parts	43
Warranty	61

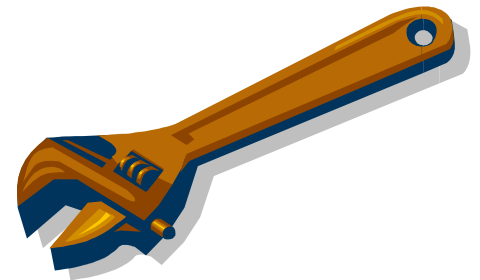
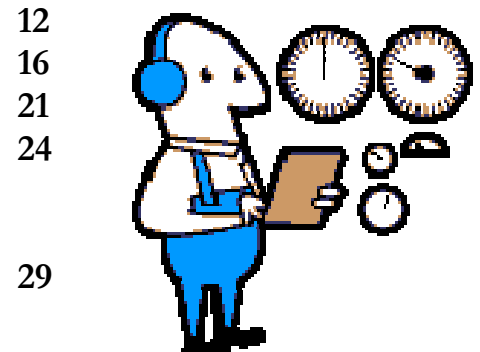

Introduction

This manual is a guide for proper service and maintenance procedures needed to maintain safe operation of this unit.

Read and understand this manual completely before performing service or maintenance on this unit.

This manual should be kept in your service department for future reference.

Any questions pertaining to the maintenance or servicing of this unit should be directed to Bridgepoint Systems.

Local regulations regarding the storage, transportation and use of propane may restrict or prohibit the operation of the TES Thermal Energy System in some areas. Check with your local fire safety authorities before operating this equipment.

Warning: Improper installation, operation, adjustment, alteration, service or maintenance can cause property damage, personal injury or loss of life. Installation and service must be performed by a qualified installer, service agency or gas provider. Bridgepoint Systems is in no way responsible and is excluded from liability in respect to any loss or damage which may arise due to improper installation, operation or maintenance.

This manual is written specifically for the TES Thermal Energy System units manufactured by:

Bridgepoint Systems

4282 S 590 W

Salt Lake City, UT 84123

801-261-1282

Information in this manual is subject to change without notice and does not represent a commitment on the part of Bridgepoint Systems.

General Information

TES HEATER ASSEMBLY

200,000 Btu Propane/LP Gas Boiler – Outdoor Model

Stainless steel covers and Stainless Steel base with powder coated steel reinforcements and mounting feet.

Height:	36-3/8" (Without wheels & vent cap) 45-7/8" (With wheels & without vent cap) 47-3/8" (Without wheels & with vent cap) 56-7/8" (With wheels & vent cap)
Length:	47-1/2" (Without handle) 50" (With handle)
Width:	25-5/8" at base 35-1/8" at widest point (Outdoor Hood)
Weight:	450 lbs.
Pump:	All stainless steel liquid end construction – Close coupled end suction single stage centrifugal pump with high temp seal. 3/4 – 1.5 HP – 3450 rpm - 75 psi Maximum liquid temperature - 250°F (120°C)

TEX THERMAL EXCHANGER

Height:	19-7/8"
Length:	24"
Width:	20-5/8"
Weight:	50 lbs.

Standard Equipment

TES Heater Assembly

1 – 10' Propane Hose with Regulator

4 - TEX Thermal Exchangers

2 - TES Hose 3/4" x 50' Red Insulated w/ 3/4" Quick connects

2 - TES Hose 3/4" x 50' Blue Insulated w/ 3/4" Quick connects

4 - TEX Hose 5/8" x 50' Red Insulated w/1/2" Quick connects

4 - TEX Hose 5/8" x 50' Blue Insulated w/1/2" Quick connects

2 - Inlet Solution Tee - 3/4" Female QC to (2) 1/2" Male QC's

2 - Outlet Solution Tee - 3/4" Male QC to (2) 1/2" Female QC's

4 - QD Wraps – Large

8 - QD Wraps – Medium

Additional / Optional Equipment

Wheel Kit:	AT52
50' Power Cord:	AX33
Shock Buster GFCI:	AX126
TES Hose 3/4" x 50' Red Insulated w/ 3/4" Quick connects:	AH108
TES Hose 3/4" x 50' Blue Insulated w/ 3/4" Quick connects:	AH110
TES Hose 3/4" x 5' Red Insulated w/ 3/4" Quick connects:	AH109
TES Hose 3/4" x 5' Blue Insulated w/ 3/4" Quick connects:	AH111
TES Hose 5/8" x 25' Red Insulated w/ 3/4" Quick connects:	AH116
TES Hose 5/8" x 25' Blue Insulated w/ 3/4" Quick connects:	AH118
TEX Hose 5/8" x 50' Red Insulated w/1/2" Quick connects:	AH112
TEX Hose 5/8" x 50' Blue Insulated w/1/2" Quick connects:	AH114
Inlet Solution Tee - 3/4" Female QC to (2) 1/2" Male QC's:	AH104
Outlet Solution Tee - 3/4" Male QC to (2) 1/2" Female QC's:	AH106
TEX Thermal Exchangers:	MB212
TES Thermal Fluid – Gallon:	CR01GL
QD Wraps – Large:	AH10L
QD Wraps – Medium:	AH10M
Adapter for Dual Propane Tanks:	AT68
Adapter for Triple Propane Tanks:	AT69
Trailer Rack for 3 Propane Tanks:	AT70
TES Trailer Mount Support Frame:	AT78
Trailer Fan Kit:	AT76
Shelf for 4 Air Movers:	AT72
Shelf for 6 Air Movers:	AT74
Trailer Vent Cap (J-cap):	NM4330
Floor Anchor:	NM4328
TES Fluid Filter Kit:	AT80

High Altitude Burner Jets:

The efficient operation of this heater depends on the proper fuel air mixture in the combustion chamber. The amount of fuel required for proper combustion will vary with changes in altitude. With less oxygen available for combustion at higher altitudes, less fuel can be burned and the Btu input rating of the heater is reduced by 4% for each 1000 feet above sea level.

The standard TES unit is designed for operation at elevations from sea level to 2000 feet. Use of the TES unit at altitudes above 2000 feet will require replacing the burner jets with smaller jets to reduce the gas flow to match the lower oxygen levels. If the jets are not changed, the excess fuel will result in poor combustion and black soot build up that will impair the heater's performance or damage the heater. Burner jet replacement should only be performed by trained technicians.

The following Burner Jets are available for operation of your TES unit at higher altitudes:

2000 – 4000 Feet:	NM4294	(4 required)
4000 – 6000 Feet:	NM4296	(4 required)
6000 – 8000 Feet:	NM4298	(4 required)

Burner jets are installed at the factory for operation at the altitude of your location at the time your unit was shipped from the factory. Check the rating plate to assure jets are matched to your altitude.

Propane Safety

Propane is highly flammable, always contained under pressure and the liquid can freeze skin. It is important to understand the safety rules for propane storage and use.

- Propane or LP-gas is a true gas compressed into liquid form for easy transportation and storage. While stored in a compressed liquid form, most appliances such as the TES Heater use propane vapor only. Propane tanks designed for vapor service must be transported, stored and used in the proper position. Do not transport, store or use vertical cylinders in a horizontal position. Never use a horizontal tank on its improper side. **Failure to follow these guidelines may allow liquid propane to get into the heating system, create unsafe conditions and damage the heater.**
- Do not fill propane tanks to more than 80% of capacity.
- Secure the tanks during transportation, storage and use to prevent falling and rolling.
- Do not use damaged or rusted tanks. Tanks that show excessive denting, bulging, gouging or corrosion must be removed from service. Do not attempt to repair propane tanks, valves or regulators.
- A two-stage propane regulator of sufficient capacity must always be installed between the propane tanks and the TES unit to assure that the gas is delivered at the correct pressure for safe operation. Unregulated propane pressure can create unsafe conditions and damage the heater.
- When connecting propane regulator and hose to the tank valve, turn the fitting nut counter-clockwise to tighten. Draw the fitting snug with the proper wrench. Do not over tighten. No thread sealant is needed.
- Do not operate the TES Heater with a propane tank inside a closed trailer.
- Keep a dry chemical fire extinguisher with a B:C rating within 50 feet of tanks during use or storage.
- Laws concerning the proper storage of propane tanks may vary in different jurisdictions. Consult your local fire protection authorities.
- Do not use a wrench to close tank valve. These valves are designed to be closed leak tight by hand. If a wrench is needed to stop leaking, remove the tank from service immediately and have the valve replaced by a qualified professional.

- Do not smoke in the area of the propane tanks or heater.
- Do not operate the TES Heater indoors.
- Position TES unit and tanks to keep tanks away from heater.
- Before operating the TES Heater check around the heater for the smell of propane. Propane gas is heavier than air and can collect in low areas. Check around base of the heater for the smell of propane.
- A distinctive odor is added to propane. However propane leaks cannot always be detected by smell. Some people do not have a good sense of smell or certain conditions may affect your sense of smell. In rare cases propane gas can lose its added odor. This is called “odor fade”. It may occur when air, water or rust accumulates in a propane tank. The smell of escaping gas can also be absorbed by water, some soils or other materials. If you think your propane gas has lost its odor contact your propane dealer to check it out.
- Electronic gas detectors are commercially available and may provide an additional means of warning about the presence of propane.
- Use soapy water to check connection for propane leaks.
- Never use a match or flame to check for propane leaks.
- If you suspect a leak:
 - Do not attempt to start heater.
 - Close the valves on the propane tanks.
 - Do not touch any electrical cords, plugs or switches in the area of the suspected leak.
 - Do not operate any phone or electrical device in the area of the suspected leak.
 - Leave the area until the propane smell dissipates. If a large amount of propane is being released or the gas cannot be dissipated, leave the area and contact the fire department.
 - Have the propane system checked and repaired before using the heater.
- Absolutely no alterations or modifications should be made to your propane system. The slightest modification or alteration to your propane system by untrained personnel may cause a potentially dangerous or life-threatening situation.
- Do not operate this heater if any part has been under water. Have a qualified propane system service technician inspect the system and replace any part of the control system that has been under water.
- Have the propane system checked annually by a qualified propane system service technician
- To reduce the risk of property damage or injury, repairs to propane systems should only be performed by experienced technicians. Contact your nearest service center for assistance.

Check with your local propane supplier for local regulations regarding the use, storage and transportation of propane.

PROPANE VAPORIZATION AND TES OPERATION

The ambient air temperature and the level of propane in the tank both affect the vaporization rate of the propane.

- At 70°F a full 100# propane tank has a maximum draw of 300,000 BTU per hour. At the same temperature a 1/2 full 100# tank has a maximum draw of 167,000 BTU per hour.
- At 0°F a full 100# tank has a maximum draw of 113,000 BTU per hour. At the same temperature a 1/2 full 100# tank has a maximum draw of 64,000 BTU per hour.

The following chart shows the number of hours the TES boiler can run in at full burn at different temperatures. This is not necessarily the maximum operation time for the TES unit. The amount of time the boiler is off or in low fire operation will increase the total use time. Higher ambient temperatures, higher structure interior temperatures as well as a lower number of TEX Thermal exchangers used and even setting the air movers on lower settings for less air flow, will all reduce the full burn time to allow much longer run times in practical applications.

To determine how many propane tanks to use, how much continuous full burn run time can be expected from a TES unit and when tanks should be re-filled or replaced to maintain the proper propane flow for the TES unit, use the following chart:

Number of 100# Propane Cylinders	Hours of TES Unit Operation at continuous full burn at various temperatures. 0-1999 Ft Operation				
	0°F	20°F	40°F	60°F	70°F
1	0	0	2.16 hrs	3.24 hrs	4.00 hrs
2	2.16 hrs	9.73 hrs	13.19 hrs	15.13 hrs	16.86 hrs
3	15.24 hrs	22.38 hrs	25.94 hrs	28.86 hrs	32.43 hrs
4	27.24 hrs	34.59 hrs	43.24 hrs	43.24 hrs	43.24 hrs

Number of 100# Propane Cylinders	Hours of TES Unit Operation at continuous full burn at various temperatures. 2000-3999 Ft Operation				
	0°F	20°F	40°F	60°F	70°F
1	0	0	2.49 hrs	3.74 hrs	4.61 hrs
2	2.49 hrs	11.21 hrs	15.20 hrs	17.44 hrs	19.44 hrs
3	17.57 hrs	25.79 hrs	29.90 hrs	33.27 hrs	37.38 hrs
4	31.40 hrs	39.87 hrs	49.84 hrs	49.84 hrs	49.84 hrs

Number of 100# Propane Cylinders	Hours of TES Unit Operation at continuous full burn at various temperatures. 4000-5999 Ft Operation				
	0°F	20°F	40°F	60°F	70°F
1	0	0	2.71 hrs	4.07 hrs	5.02 hrs
2	2.71 hrs	12.20 hrs	16.54 hrs	18.98 hrs	21.15 hrs
3	19.12 hrs	28.07 hrs	32.54 hrs	36.21 hrs	40.68 hrs
4	34.17 hrs	43.39 hrs	54.24 hrs	54.24 hrs	54.24 hrs

Number of 100# Propane Cylinders	Hours of TES Unit Operation at continuous full burn at various temperatures. 6000-7999 Ft Operation				
	0°F	20°F	40°F	60°F	70°F
1	0	0	2.96 hrs	4.44 hrs	5.79 hrs
2	2.96 hrs	13.31 hrs	18.04 hrs	20.71 hrs	29.58 hrs
3	20.85 hrs	30.62 hrs	35.50 hrs	39.49 hrs	44.37 hrs
4	37.27 hrs	47.33 hrs	59.16 hrs	59.16 hrs	59.16 hrs



- Do Not Use



- Not Recommended

- The heater may continue to burn longer than these times indicate, but the heat input from the propane available to heat the fluid will be less than the 200,000 BTU maximum.

Heater Operation Safety

This heater is designed for outdoor use. It is not to be operated indoors.

- The TES unit was designed for outdoor use and **is not** to be used indoors. The TES unit can be operated from an enclosed trailer with the proper installation and venting for combustion air and exhaust. Do not operate the TES unit in a trailer with the trailer doors open. Do not place TES unit where exhaust fumes can enter buildings. The TES unit must be at least 10 ft. away from any door, window or gravity air inlet into any building and at least 3 ft. from any overhang.
- **The TES unit must level during operation.** Using the heater in a sloped position will change the position of the burner flame in relation to the burner tubes and heat exchanger. This can result in property damage, personal injury or loss of life.
- Secure TES unit and propane tanks as needed to prevent movement during operation. Position TES unit and tanks to keep tanks away from heater.
- Colder temperatures will decrease the vaporization rate of Propane and may require the use of additional tanks and more frequent refilling of the tanks to supply enough propane to maximize heater output. (See chart on page 8)
- Do not use the TES unit if outdoor temperature may drop close to or below -30°F. TES Thermal Fluid has a freezing point of approximately -30°F. If the heater shuts off, freezing of the fluid will cause severe damage to the TES unit, TES Thermal Exchangers, hoses and fittings. Store your equipment indoors and protect from freezing.
- Do not place the TES unit in a location that would subject it to runoff from adjacent buildings.
- The combustion of propane produces carbon dioxide, carbon monoxide and oxides of nitrogen. An adequate supply of combustion air and sufficient ventilation is required to prevent these compounds from accumulating in toxic concentrations. Carbon monoxide is a colorless and odorless gas. If you are exposed to carbon monoxide, you may experience any or all of these symptoms:
 - Headaches, tightness across the forehead and temples.
 - Weariness, weakness, dizziness and vomiting.
 - Loss of muscular control. Watering and smarting of the eyes.

If any of these symptoms should develop, get into fresh air immediately, see your doctor for treatment and have your heater checked and repaired as needed.

- If the TES unit is to be installed for use in a closed trailer. It must have an exhaust stack installed to vent the burner exhaust through the roof of the trailer. There must be sufficient ventilation to exhaust the heat and supply adequate combustion air to the burner. Do not operate the TES unit in a trailer with the trailer doors open. A power fan must be used to bring combustion air into the trailer. In a closed locked trailer the control panel door should be left open to keep the gauges and controls cooler.
- A 7" diameter exhaust stack with vent cap is required. A "J" cap or other wind resistant vent cap should be used. Never install an exhaust pipe of a diameter smaller than the recommended size. 6" of clearance is required between the exhaust stack and any combustible materials. Use the shortest, straightest exhaust system possible.
- Two roof vents must be installed to exhaust the heat from the trailer and allow proper flow of combustion air. The roof vents must have a total minimum free area of 100sq. in. When calculating the vent area, consideration must be given to the blockage effects of louvers, grills and screens. The installation of two roof vents should easily provide sufficient vent air space when allowing for blockage. **Power vents should not be used.** The heater should not be subjected to negative air pressure. Negative air pressure can affect the burner flame and exhaust flow.
- Openings for the combustion air supply must have a total minimum free area of 100 sq. in. When calculating the vent area, consideration must be given to the blockage effects of louvers, grills and screens. The openings must be within 12" but not less than 3" from the floor of the trailer. A power inlet air fan must be used to bring in combustion air. The free air space of the hose access door can be used as part of the total vent space. The blockage of the hoses must be considered when calculating the free space of the hose access door. The hoses may reduce the total free area to a total less than the required 100 sq. in. and require the addition of a second vent.

This heater is an electrical appliance. Care must be taken to reduce the risk of electrical shock. Use of a Ground Fault Interrupting (GFI) device is recommended.

- Extension cords must be rated for outdoor use, grounded and able to deliver the proper current to the heater and pump. (10 amps)
- Do not use a multiple outlet power cord to connect to TES unit plug.
- Keep cord connections off the ground. Protect cord connections from rain or other water sources.
- Never operate this heater with a damaged power cord. If the power cord is damaged it must be replaced.
- Unplug machine power cord from outlet before connecting or disconnecting quick connects on TES unit.
- Unplug machine power cord from outlet before performing any repair on the TES heater or pump.
- To reduce the risk of property damage or injury, repairs to electrical systems should only be performed by experienced technicians. Contact your nearest service center for assistance.
- If solution lines, pump or heater are leaking, unplug machine power cord from outlet before approaching or touching machine.
- Remove Feet or carpet clamps from snout of air mover before placing air mover into TEX Thermal Exchanger to prevent damage to air seal gasket.

This heater operates with hot solution under pressure. TES Thermal fluid under pressure and at high temperature can cause burns, severe personal injury or death. The TES Thermal Energy System must be operated and maintained properly to reduce the risk of burns or other injuries.

- Always connect at least two TEX Thermal Exchangers with hoses, make sure manual pressure relief valve is closed and by-pass valve open before turning Pump and Heater ON
- Always turn Pump ON before turning Heater ON. Always turn Heater OFF and allow solution to cool before turning Pump OFF. The air movers must be kept running in each TEX Thermal Exchanger to draw heat and cool the solution.
- Turn Heater OFF, allow solution to cool, then turn Pump OFF and disconnect power cord before relieving system pressure and disconnecting any hose from the TES unit. Turn Heater OFF, allow solution to cool, then turn Pump OFF and relieve system pressure before disconnecting any hose from the thermal exchangers, solution tees or other hoses. Wear eye protection when connecting and disconnecting hoses.
- Stainless steel covers and doors have sharp edges. Wear leather work gloves when connecting or disconnecting quick connects or performing maintenance or repair procedures on the TES unit.
- With pump OFF, hoses and fittings will retain 12 psi system pressure. When system has cooled, use the manual pressure relief valve to release pressure from system before disconnecting hoses. Quick connects may stick open and leak. Press nipple on quick connect to release fluid and flush debris and allow the quick connect to re-seal. Wrap a towel around quick connects when disconnecting hoses to catch released fluid.
- Do not operate this heater unless all panels are in place and properly secured. Keep hose access door on TES unit closed and locked during operation. Keep control panel door on TES unit closed and locked during operation. Do not leave keys in locks. (Control panel door should be left open when operating unit inside a locked trailer.)
- Keep cover on TES fluid reservoir during operation. Add TES Thermal Fluid to reservoir as needed to maintain an adequate fluid supply to pump and heater. Do not use water in heater, hoses or heat exchangers. Use only TES Thermal Fluid. Failure to do so may result in damage to the heater and will void the warranty.
- Hot brass fittings can damage some carpets or cause burns. Wrap and insulate quick connects and solution tees to prevent damage or burning.
- Hoses must be rated to handle 250°F fluid temperatures, 5/8" or 3/4" ID for adequate flow and insulated to hold heat and protect from burns.
- Do not by-pass Flow Switch. A continuous adequate flow of solution through heater must be maintained. Failure to do so may result in damage to heater and will void warranty.
- Never try to repair the pressure relief safety valve. If the valve fails to operate properly, replace the valve. Removal or restriction of the pressure relief valve could damage heater, cause severe personal injury or death.
- If solution lines, pump or heater are leaking, unplug machine power cord from outlet before approaching machine.

Heater Operation Procedure

Knowledge of the proper operation of the heater and heat exchange system is required for safe operation and to keep heater and components operating properly.

- 1) Place the TES unit in an area close to a convenient entry point for hoses to heat exchangers. Heater must be level and in a well ventilated area. Consideration must be given to the security of the selected area in regards to theft, tampering and safety. Place and secure TES unit to prevent movement during operation.
- 2) Propane tanks must be placed in proper use position on a solid level area and secured if necessary to prevent tipping. Position TES unit and tanks to keep tanks away from heater.
- 3) Connect the hoses to the outlet and inlet quick connects and run hoses to TEX Thermal Exchangers as needed. Wear leather gloves and eye protection when connecting hoses. **For proper heater operation two or more TEX Thermal Exchangers must be connected to the heater.** For extended hose runs use more 3/4" TES hoses for improved flow. Place quick connect wraps on all hose connections to hold heat and prevent burning from contact with hot brass fittings.
- 4) Add TES Thermal Fluid to reservoir as needed to keep fluid level above half full.
- 5) Connect the power supply cord to the TES heater.
- 6) Connect the propane hose and regulator to the propane tank. Use a tee connector to connect two or three tanks together for larger jobs. Operation time per 100 lb. tank is dependant on altitude and heat draw requirements. Heat draw requirements can change with the outside temperature, number of TEX Thermal Exchangers, length of hose used and air flow required to float the carpet. The average operation time per tank using four TEX Thermal Exchangers is 12-16 hours. Longer operation time can be expected using fewer heat exchangers. Shorter operation time can be expected in lower temperature use, when the decrease in the vaporization rate will decrease the BTU/hr available from each propane tank.
- 7) Open the valves on the connected propane tanks. Open valve slowly to allow lines to slowly pressurize. Opening valve too quickly may activate flow restrictor valve in POL fitting and stop gas flow to heater.

Wait 5 minutes and check around heater, tanks and hoses for gas leaks.

- If no gas leaks are detected proceed with start up procedures.
- If a gas leak is detected or suspected, close tank valves and follow safety procedures.

- 8) Make sure the manual pressure relief valve is closed and open the by-pass valve located between the quick connects and then turn the pump ON to circulate solution through heater and activate flow switch. Listen for air release or cavitation in pump. Observe pressure gauge reading. Pressure reading will vary with the number of TEX units used, the length hose used and position of by-pass valve. Gauge should read between 30 – 50psi and pressure will stabilize as air is removed from the system. Add TES Thermal Energy Fluid to reservoir as needed. Excessive cavitation, air release or fluid loss may indicate a system fluid leak. Check fittings, hoses and TEX Thermal exchangers for leaks and repair or replace as needed.
- 9) For maximum heat production the by-pass valve, located between quick connects, should be closed. However, depending on the number of TEX units connected, the by-pass valve may need to be opened to maintain the required fluid flow rate through the TES heater. The valve should be opened before turning the pump on. Now slowly close the valve until the valve is closed completely or the LOW FLOW light turns off.
 - If the valve can be closed and LOW FLOW light stays on, leave the valve closed and continue with set-up.
 - If the LOW FLOW light turns off, slowly open the valve until the light comes back on. When the light comes on, open the by-pass valve an extra 1/2 turn and continue with set-up.
- 10) Turn TES unit heater switch to the ON position. Observe indicator lights. When all lights are illuminated system is within operating limits and the heater is firing.
 - **POWER** – When lighted indicates that the heater switch is in the ON position and the heater has power.
 - **OPERATOR** – When lighted indicates that the solution temperature is below the preset temperature limit and the heater can fire. Operator set point is 200°F, preset at the factory.
 - **HI-LIMIT** – When lighted indicates that the solution temperature is below the Hi-Limit safety setting and the heater can fire. The Hi-Limit set point should be at least 20°F above the Operator set point. And never set above 230°F.
 - **LOW FLOW** – When lighted indicates there is adequate solution flow and the heater can fire.
 - **MAIN GAS** – When lighted indicates the main gas valve is open and the heater is firing.
 - When the lights are not all lighted look for the following: See the troubleshooting section for more information on the meaning different light configurations.
 - When the **LOW FLOW** light does not come on, make sure you have all your hoses connected to the TEX Thermal Exchangers and the pump is ON and running. (For better flow and heater operation have at least two TEX Thermal Exchangers connected.) Then open the by-pass valve slowly until the **LOW FLOW** light comes on. Once the **LOW FLOW** light comes on continue opening the by-pass valve 1/4 – 1/2 turn. If the **LOW FLOW** light does not come on recheck your hose connections and repeat the procedure or contact your nearest service center for advice or assistance.
 - If all the other lights are on, but the **MAIN GAS** light does not come on, turn the heater switch off and turn it back on again wait 5-10 seconds and repeat as needed. It may take a few tries to get the air out of the propane lines and allow the heater to fire.
 - When the solution temperature reaches the Operator set point, the **OPERATOR**, **LOW FLOW** and **MAIN GAS** lights will turn off and the heater will stop firing.
 - When the Solution temperature reaches the Hi-Limit set point, the **HI-LIMIT** and **MAIN GAS** lights will turn off and the heater will stop firing.
 - If the solution flow rate is too low, the **LOW FLOW** and **MAIN GAS** lights will turn off and the heater will stop firing.

- 11) Turn the air movers ON for each TEX unit.
- 12) Observe TES unit operation until the temperature stabilizes or the operator set point is reached for the first time and then heater re-starts after cooling. Open by-pass valve as needed to maintain proper flow rate to engage flow switch on heater. As the system heats up, pressure and flow rate may change and the by-pass valve may need to be re-adjusted to maintain flow and keep the heater firing.
- 13) When the TES unit is adjusted properly and operating normally, close and lock hose access door and then close and lock control panel cover on TES unit. (Control panel door should be left open when operating unit inside a locked trailer.)

CHANGING PROPANE TANKS

- 1) Unlock and open control panel.
- 2) Turn TES unit heater OFF. Leave pump switch ON.
- 3) Close valves on propane tanks. Close gas shutoff valve between tanks and TES unit if so equipped. Remove regulator and hoses from propane tanks.
- 4) Reconnect regulator and hoses to new, full propane tanks.
- 5) Slowly open valves on propane tanks. Then slowly open gas shutoff valve if so equipped.
- 6) Check for propane leaks. If leaks are found or suspected follow safety procedures. If no leaks are detected continue with procedure.
- 7) Turn TES unit heater switch to the ON position. Observe indicator lights. When all lights are illuminated system is within operating limits and the heater is firing. If all the other lights are on, but the **MAIN GAS** light does not come on, turn the heater switch off for 5-10 seconds and turn it back on again wait 5-10 seconds and retry as needed. It may take a few tries to get the air out of the propane lines and allow the heater to fire.
- 8) Observe TES unit operation until temperature stabilizes or solution temperature returns to the operator set point. Open by-pass valve as needed to maintain proper flow rate to engage flow switch on heater. As the system heats up, pressure and flow rate may change and the by-pass valve may need to be re-adjusted to maintain flow and keep the heater firing.
- 9) When the TES unit is adjusted properly and operating normally, close and lock control panel cover on TES unit. (Control panel door should be left open when operating unit inside a locked trailer.)

HEATER SHUTDOWN PROCEDURE

- 1) Unlock and open control panel on TES unit.
- 2) Turn TES unit heater switch OFF and leave pump switch ON.
- 3) Close valves on propane tanks. Close gas shutoff valve between tanks and TES unit if so equipped.
- 4) Keep air movers running through TEX Thermal Exchangers to draw heat and cool the heating system.
- 5) When the solution temperature has cooled to the point where you can comfortably handle the quick connects and hoses (Approximately 120°F or lower.) turn the pump OFF.
- 6) Turn the air movers OFF at each TEX unit.
- 7) Unlock hose access door on the TES unit.
- 8) Disconnect power cord from the power outlet and heater connection. Roll up and store cord.
- 9) With pump OFF, hoses and fittings will retain 12 psi system pressure. Use the manual pressure relief valve to release system pressure before disconnecting hoses. Close valve when pressure has returned to zero.
- 10) Disconnect hoses from TES Heater and TEX Thermal Exchangers. Wear eye protection and leather gloves when disconnecting or connecting hoses. Quick connects may stick open and leak. Press nipple on quick connect to release fluid and flush debris and allow the quick connect to re-seal. Wrap a towel around quick connects when disconnecting hoses to catch released fluid.
- 11) Roll up and store hoses.
- 12) Disconnect propane regulator and hose from tank. Store propane hose and regulator.
- 13) Remove and store air movers and TEX Thermal Exchangers.
- 14) Store propane tank and heater.

Heater Troubleshooting

Problem	Cause	Solution
Circuit Breaker Blowing	Too much current demand on circuit	Move plug to another outlet & circuit
	Circuit breaker faulty	Move plug to another outlet & circuit
	Faulty Pump - Pump seized	Repair or replace pump as needed
	Pump motor faulty	Replace pump motor
	Restriction in hoses and fittings	Remove and clean or replace hoses & fittings as needed
	Faulty power cord	Replace cord
	Faulty switches or internal wiring	Check wiring & test switches - Repair as needed *
Solution Pump not running	Pump Switch in OFF position	Turn pump switch ON
	Building circuit breaker tripped.	Reset breakers or move cord to another outlet
	Faulty power cord	Replace cord
	Faulty switches or internal wiring	Check wiring & test switches - Repair as needed *
	Pump thermal protector tripped	Allow pump motor to cool and restart
	Pump motor faulty	Replace pump motor
	Pump seized - trips breaker	Repair or replace pump head - Check motor
Solution Pump Not Pumping	Air in System	Prime pump & bleed air from system – Add Fluid as needed. Check System pressure pump, Pressure Reducing Valve and wiring.
	Low on Fluid	Add fluid, prime pump & bleed air from system
	Faulty Pump	Repair or replace Solution Pump
	Low Voltage	Check wiring & test switches - Repair as needed *
	Restriction in hoses and fittings	Remove and clean or replace hoses & fittings as needed
Heater Power Light Not Lighted	Heater Switch in OFF position	Turn Heater Switch ON
	Building circuit breaker tripped.	Reset breakers or move cord to another outlets
	Faulty power cord	Replace cord
	Heater Fuse Blown	Replace 2 amp fuse & Check wiring & test - Repair as needed *
	Faulty switches or internal wiring	Check wiring & test switches - Repair as needed *
	Faulty indicator light	Replace light
Heater Operator Light Not Lighted	Solution temperature above set point	Normal Operation - If needed raise set point
	Loss of power	See Power Light (All other lights also off.)
	Faulty switches or internal wiring	Check wiring & test switches - Repair as needed *
	Faulty indicator light	Replace light

* To reduce the risk of injury, repairs to electrical, propane or fluid pressure systems should only be performed by experienced technicians. Contact your nearest service center for assistance.

Problem	Cause	Solution
Heater Low Flow Light Not Lighted	Flow rate too low	Check Pump - Open by-pass valve to increase flow.
	Solution temp over operator set point	Normal Operation (Operator light also off.)
	Loss of power	See Power Light (All other lights also off.)
	Faulty switches or internal wiring	Check wiring & test switches - Repair as needed *
	Faulty indicator light	Replace light
Heater Hi-Limit Light Not Lighted	Solution temperature above set point	Normal Operation - If needed raise set point
	Loss of power	See Power Light (All other lights also off.)
	Faulty switches or internal wiring	Check wiring & test switches - Repair as needed *
	Faulty indicator light	Replace light
Heater Main Gas Valve Light Not Lighted	Solution temp over operator set point	Normal Operation
	Solution temp over Hi-limit set point	Normal Operation
	Flow rate too low	Check Pump - Open by-pass valve to increase flow.
	Loss of power	See Power Light (All other lights also off.)
	Failed Ignition	Check Propane supply - Check Flow rate - Restart heater
	Faulty Valve	Replace Main Gas Valve*
	Faulty switches or internal wiring	Check wiring & test switches - Repair as needed *
	Faulty indicator light	Replace light
System Overheating	Out of Propane	Refill Tanks - Check Hoses, regulator and connections
	Faulty switches or internal wiring	Check wiring & test switches - Repair as needed *
	Flow rate too low	Check Pump - Open by-pass valve to increase flow.
System Not Heating	Not enough Heat draw from system	Turn air movers switches to higher speed Increase number of TEX Thermal Exchangers
	Faulty switches or internal wiring	Check wiring & test switches - Repair as needed *
	Out of Propane	Refill Tanks - Check Hoses and connections
	Thermostats set too low	Adjust thermostats - Raise set points
	Too Much Heat loss from system	Turn air movers switches to lower speed Reduce number of TEX Thermal Exchangers Reduce length of hose being used – Insulate fittings
	By-pass Valve opened too much	Adjust by-pass valve as needed
	Flow Rate too low	Check pump, hoses and connections. Adjust by-pass valve
Heater Cycling Too Often	Faulty Heater	Check heater jets, burners, etc – Repair as needed*
	Faulty switches or internal wiring	Check wiring & test switches - Repair as needed *
	Flow rate too low	Check Pump - Open by-pass valve to increase flow. Increase number of TEX Thermal Exchangers Check hoses – Hose may be restricted Un-kink, repair or replace hoses
	Not enough Heat draw from system	Turn air movers switches to higher speed Increase number of TEX Thermal Exchangers
	By-pass Valve opened too much	Adjust by-pass valve as needed

* To reduce the risk of injury, repairs to electrical, propane or fluid pressure systems should only be performed by experienced technicians. Contact your nearest service center for assistance.

TES INDICATOR LIGHT PANEL CONFIGURATIONS

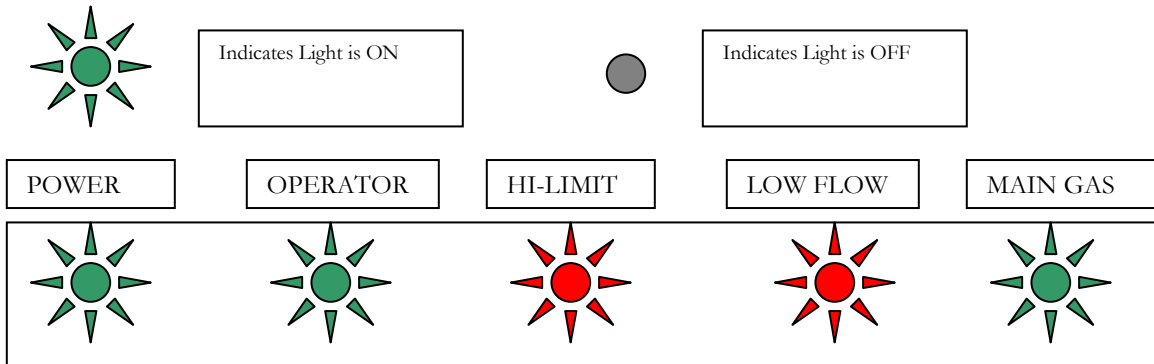

When all the lights are ON as shown above, the heater is operating normally and the heater is firing.

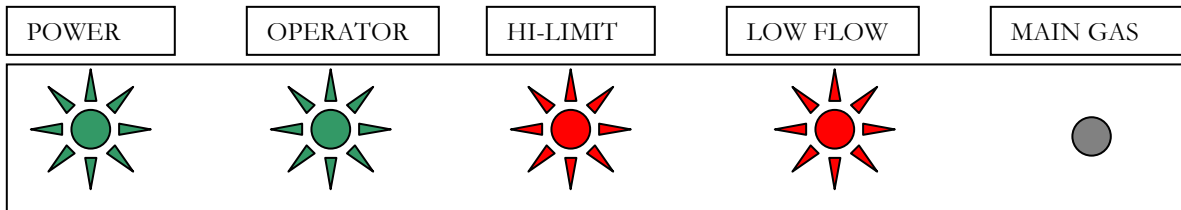

When the POWER, OPERATOR, LOW FLOW and HI-LIMIT lights are all ON and the MAIN GAS light is OFF, it means a lack of propane or ignition failure is preventing the burner from firing. This is a common occurrence at initial start up as air is bled from the propane hoses. Check the propane supply and shutoff valves to be sure propane is being supplied to the heater. Turn the power switch ON, wait 5-10 seconds for ignition to fire and if the burner does not fire and light does not come turn switch OFF and back on to repeat ignition process. This procedure may need to be repeated several times to get air out of the lines and allow the burner to fire.

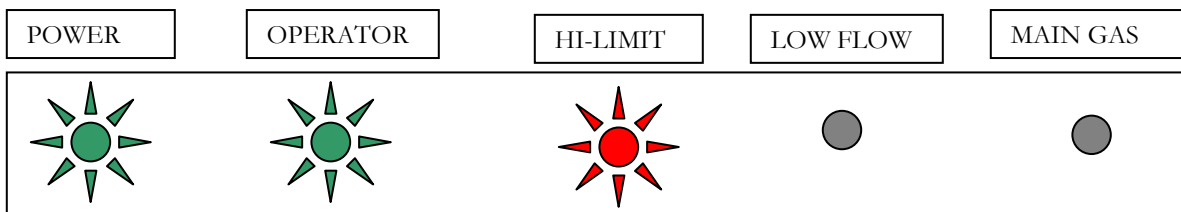

When the POWER, OPERATOR and HI-LIMIT lights are ON and the LOW FLOW and MAIN GAS lights are OFF it is an indication that the solution flow is too low to trigger the Flow Switch and the burner will not fire. Make sure pump switch is ON; pump is running and showing pressure on gauge. At least two TEX Thermal Exchangers must be connected for proper flow. With the TEX units connected and pump ON, open the By-Pass Valve to increase the solution flow. Open the valve slowly until the LOW FLOW light comes ON. Once LOW FLOW light comes ON continue opening the by-pass valve 1/4 – 1/2 turn. If the LOW FLOW light does not come ON recheck your hose connections and repeat the procedure.

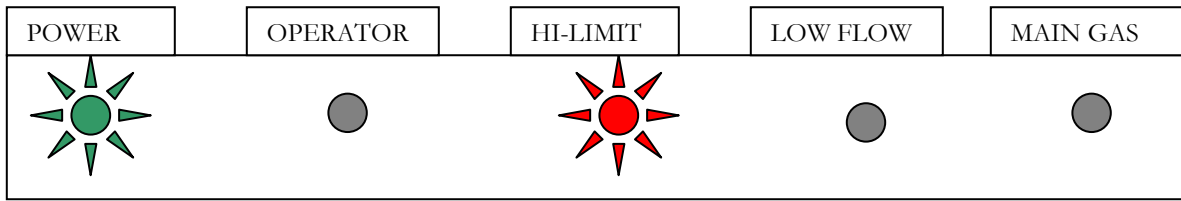

During normal operation there may be times when the POWER and HI-LIMIT lights are ON and the other lights are OFF. This indicates that the Operator set point temperature has been reached and the heater is not firing. When the Operator set point is reached the burner shuts OFF and the MAIN GAS light goes OFF. The power to the Flow switch and LOW FLOW light goes through the Operator control, so when the OPERATOR light goes out when the Operator set point is reached the LOW FLOW light will turn OFF too. When the solution temperature cools below the Operator set point the lights will all come back ON. The Operator set point is 200°F.

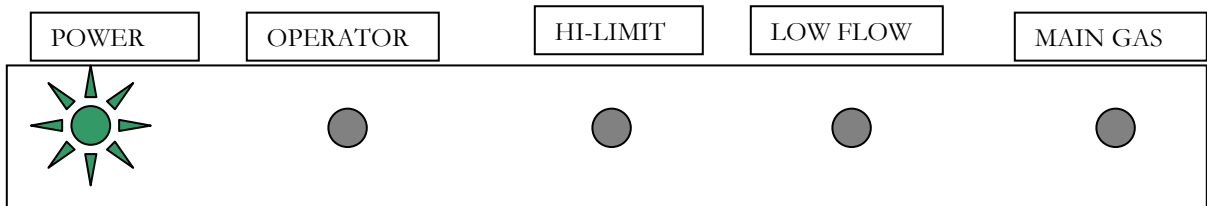

When the POWER light is the only light ON, it indicates that the solution temperature has exceeded both the Operator set point and the Hi-Limit set point and the burner has shut OFF. This could mean that the Hi-Limit set point is set too low or that there is a flow restriction to the TEX units and the heater is getting too hot. The Operator set point should be 200°F and the Hi-limit set point should be 230°F. If only one TEX unit is connected and the by-pass valve is opened too much or there is a flow restriction that reduces the amount of heat draw from the system the heater may overheat and exceed the Hi-Limit set point even if it is adjusted properly. Re-set Operator and Hi-Limit controls and add TEX units to improve flow as needed to correct the overheating. If this light pattern occurs while the TES unit is cool and control temperatures are properly set, it could indicate an electrical problem in the control panel contact your nearest service center for assistance.

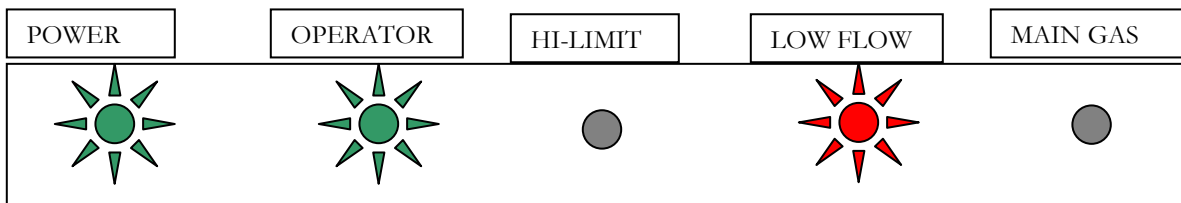

If the HI-LIMIT and MAIN GAS lights are OFF and the POWER, OPERATOR and LOW FLOW lights are ON, there is a problem with the light panel or other wiring. The power to the OPERATOR, LOW FLOW and MAIN GAS lights flows through the HI-LIMIT control first. So if the HI-LIMIT light is OFF the other three lights would also be OFF. Repair the wiring or contact your nearest service center for assistance.

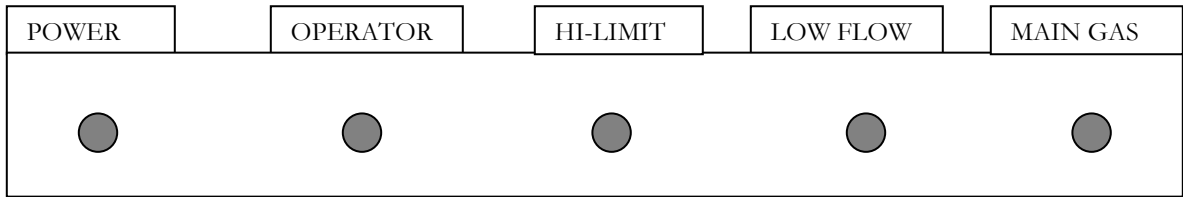

If all lights are OFF, the heater switch may be in the OFF position. Turn switch ON and check power supply to assure that power is being supplied to the TES unit. If the lights are still OFF remove Hood Assembly to access wiring and check fuse. Replace 2 amp fuse as needed or contact your nearest service center for assistance.

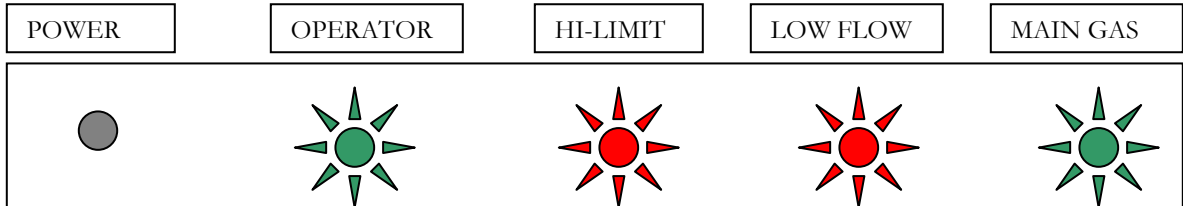

If the POWER light is OFF and the other lights are ON there is a problem with the light panel or other wiring. Contact your nearest service center for assistance.

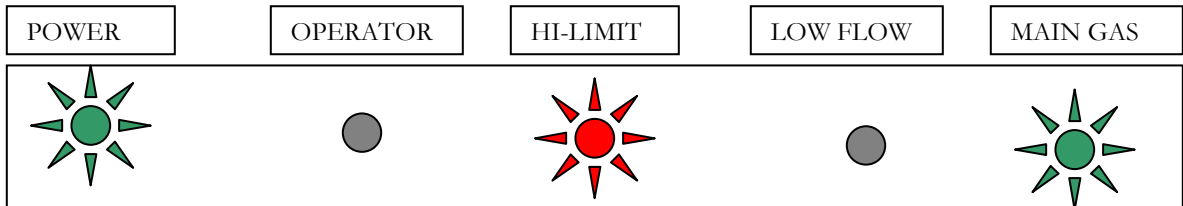

If the POWER, HI-LIMIT and MAIN GAS lights are ON, and the OPERATOR and LOW FLOW lights are OFF there is a problem with the light panel or other wiring. Contact your nearest service center for assistance.

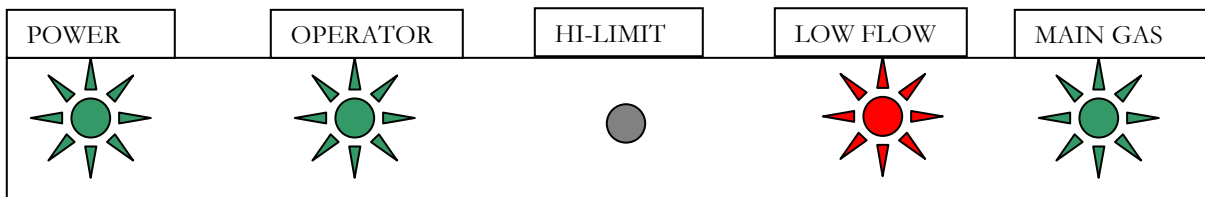

If the POWER, OPERATOR, LOW FLOW and MAIN GAS lights are ON and the HI-LIMIT light is OFF there is a problem with the light panel or other wiring. Contact your nearest service center for assistance.

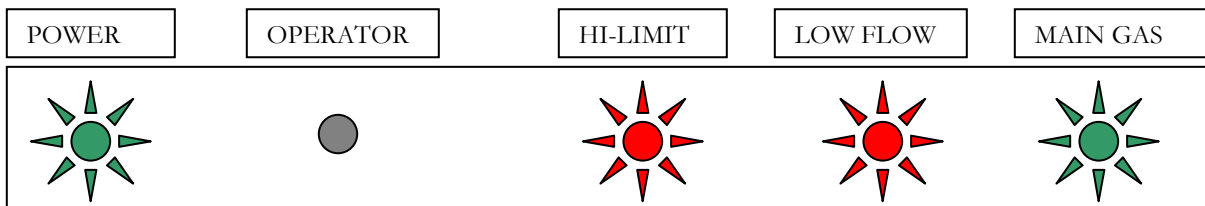

If the POWER, LOW FLOW, HI-LIMIT and MAIN GAS lights are ON and the OPERATOR light is OFF there is a problem with the light panel or other wiring. Contact your nearest service center for assistance.

Section
2

Heater Flow Path

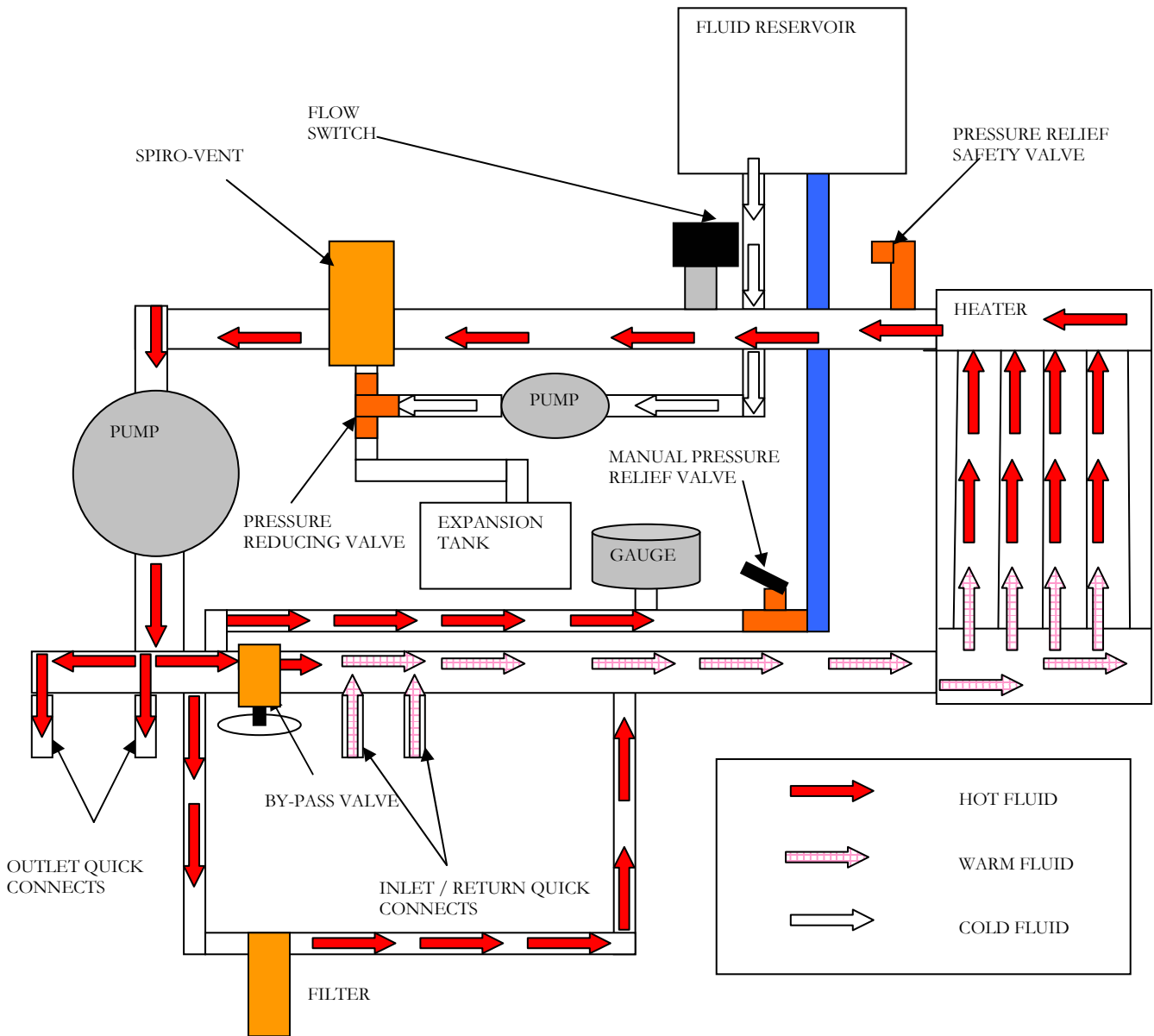

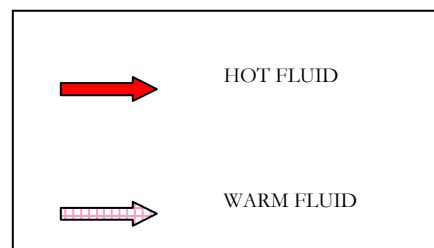
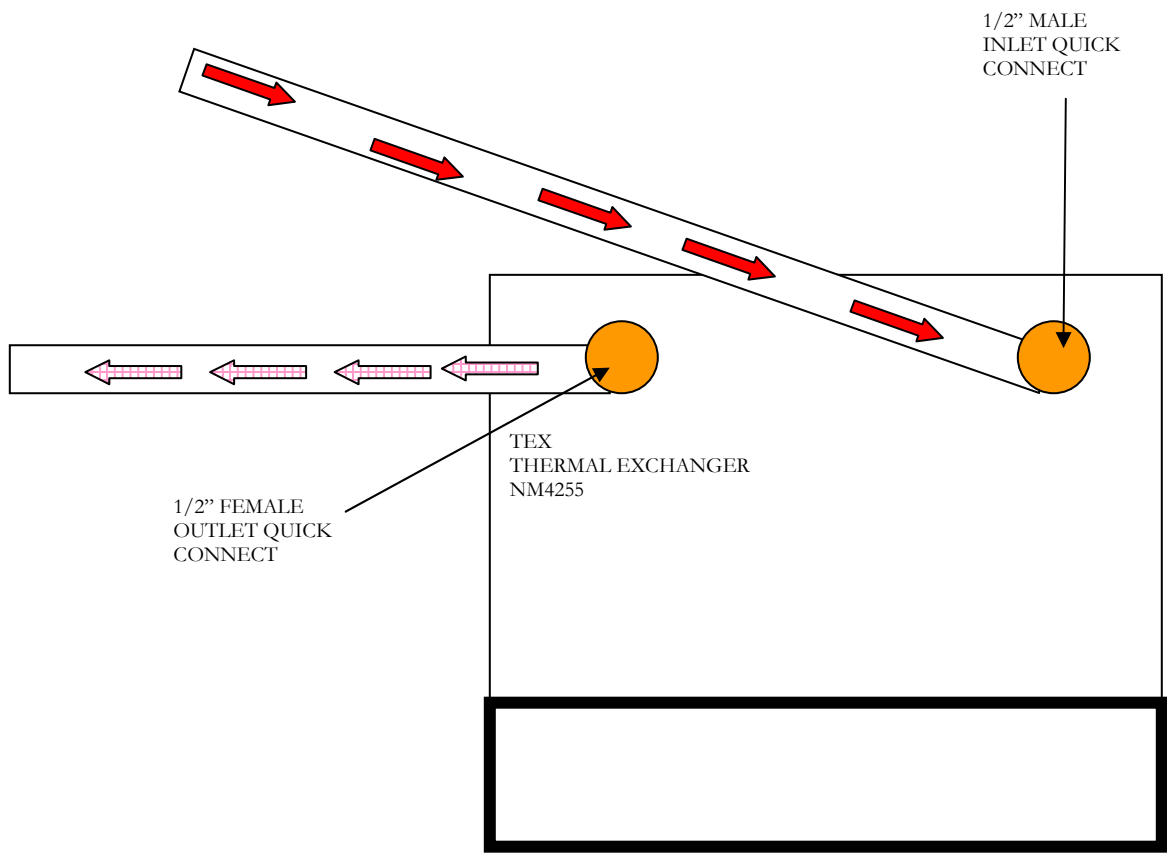

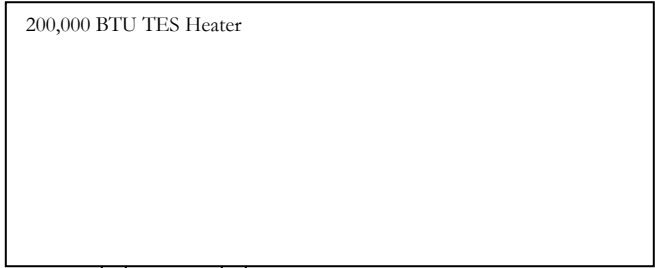

TES Outlet Hose
3/4" x 50' Red
with 3/4" QC's
AH108

TES Inlet Hose
3/4" x 50' Blue
with 3/4" QC's
AH110

For extended hose runs use
additional sections of TES 3/4"
hose for improved flow.

Inlet Solution Tee
AH104

Outlet Solution
Tee AH106

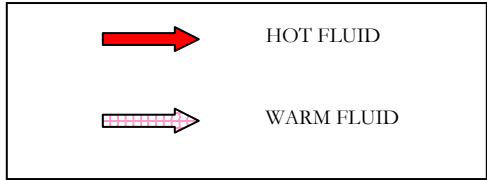

TEX Inlet Hose
5/8" x 50' Red
with 1/2" QC's
AH112

TEX Outlet Hose
5/8" x 50' Blue with 1/2" QC's
AH114

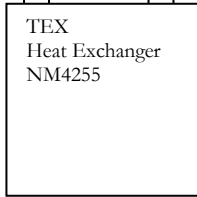
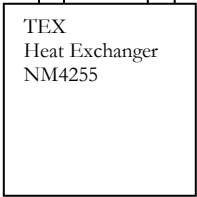

TES Wiring Diagram

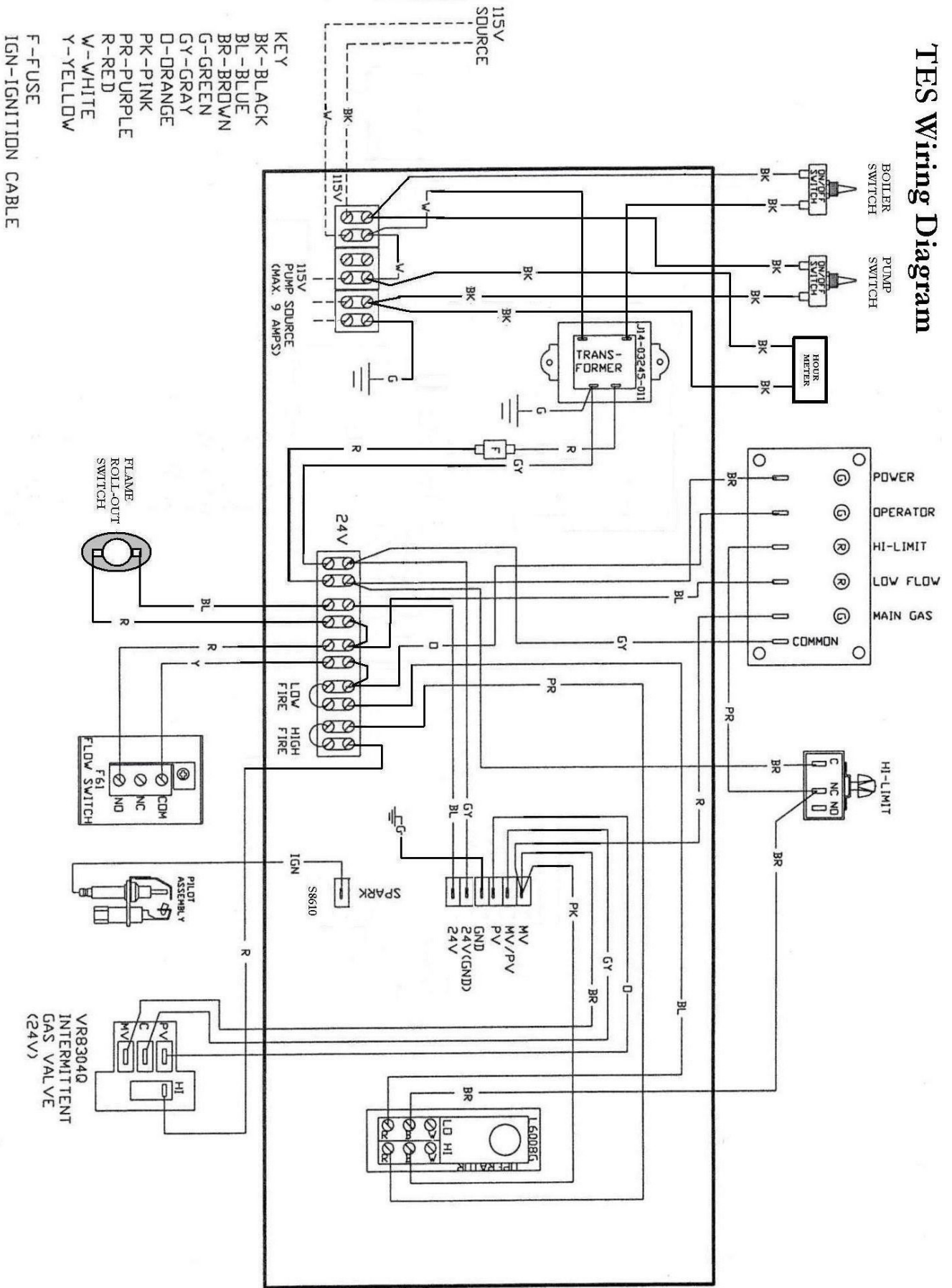

TES Wiring Diagram

Old style without Flame Roll-out Switch

CHANGES

APPROVED BY:

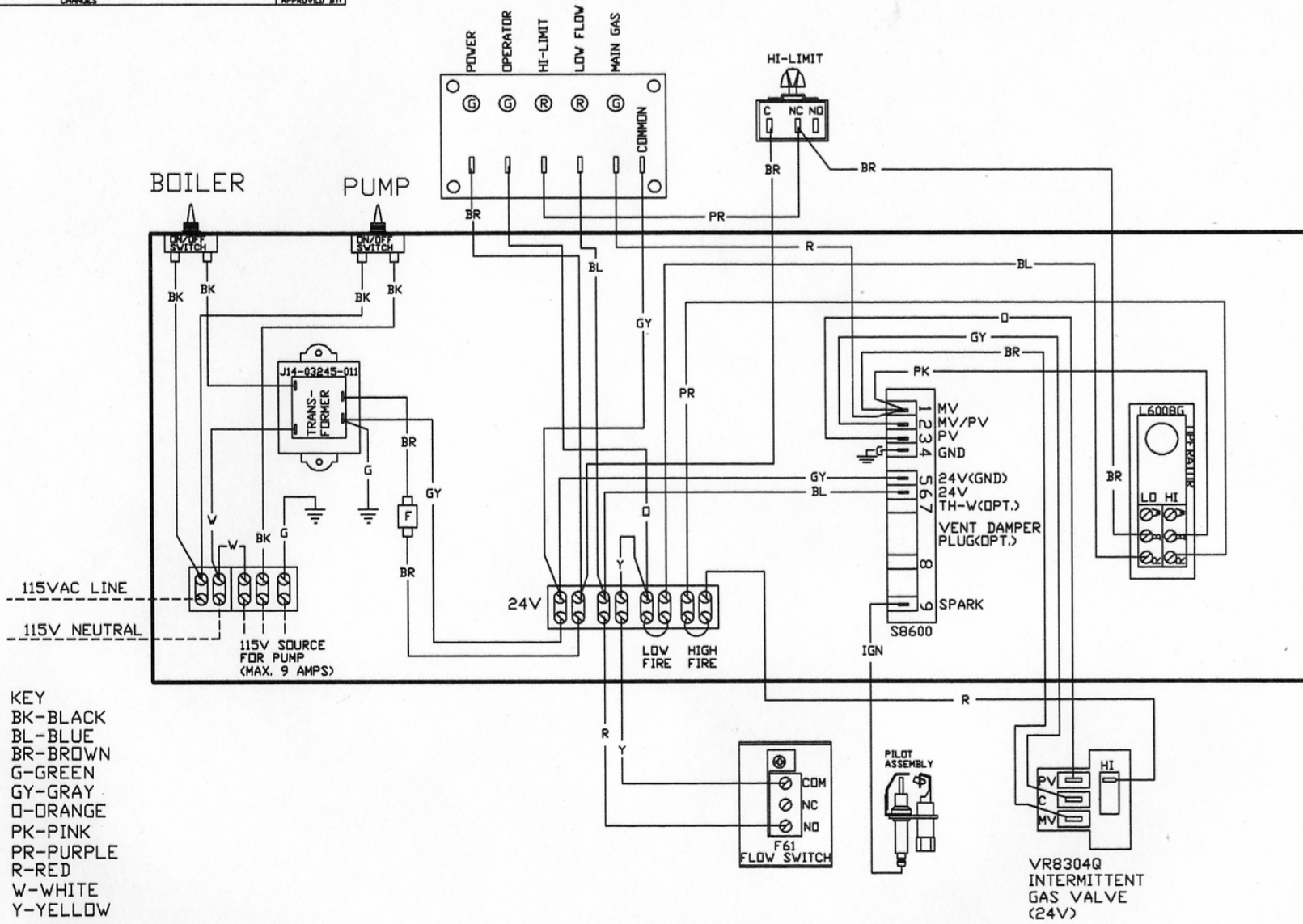

- KEY
- BK-BLACK
 - BL-BLUE
 - BR-BROWN
 - G-GREEN
 - GY-GRAY
 - Ø-ORANGE
 - PK-PINK
 - PR-PURPLE
 - R-RED
 - W-WHITE
 - Y-YELLOW
 - F-FUSE
 - IGN-IGNITION CABLE

TOLERANCES
UNLESS OTHERWISE SPECIFIED

- 1/4 ON FRACTIONAL DIMS.
- ON DECIMAL DIMS.

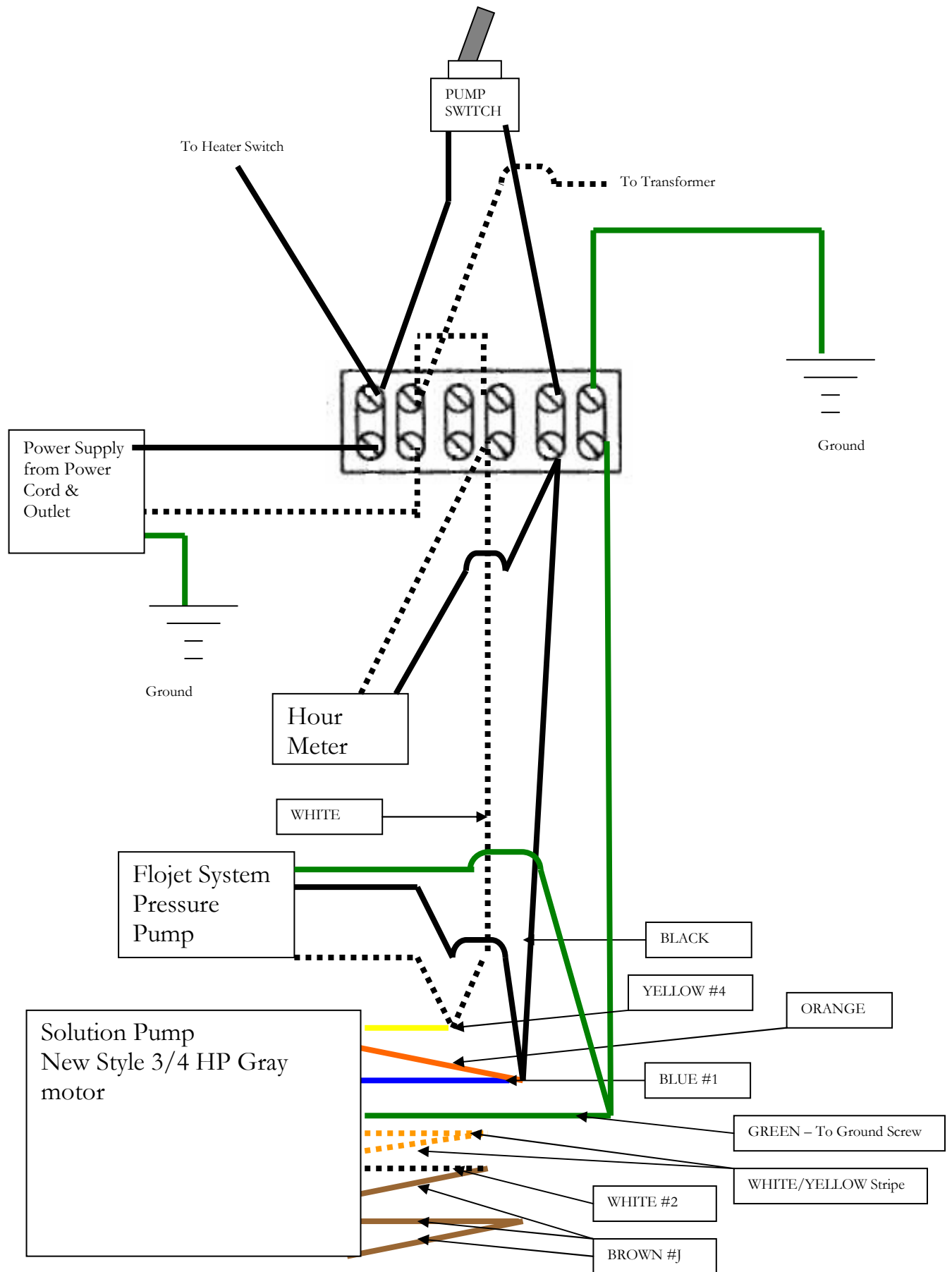

Heater Maintenance & Service

Proper maintenance is required to keep the heater operating properly, prevent downtime and to extend the life of your equipment.

Caution: Servicing, inspection and adjustment must be done by trained technician in accordance with all applicable local and national codes. Improper servicing or adjustment can damage the heater.

WARNING: Disconnect electrical power and shutoff propane tank valve before performing any service or maintenance. Failure to do so may result in severe personal injury or death.

The heater should be thoroughly cleaned and inspected once a year. A general inspection should be performed before every job. Make sure that the burners and ignition components are free from dust, soot, dirt corrosion or other deposits that would impair the heater's performance or create a dangerous condition.

Visually check the pilot and main burner flames to ensure proper operation.

WARNING: Yellow, floating flames indicate a lack of combustion air. Do not operate the boiler until the problem is solved or severe personal injury or death may occur.

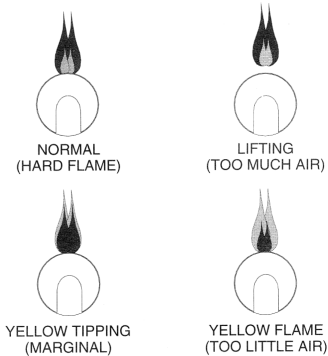

1) Propane Gas Pressure:

An inlet manifold pressure of 12" WC must be maintained for proper operation of the heater. Check and adjust as follows:

- Connect the propane regulator and hose to the propane tank. (Testing is best when performed with a full tank.)
- Remove plug and attach a manometer to the inlet pressure tap on the main gas valve.
- Remove the regulator adjustment screw cap from the gas regulator.
- Open the valve on the propane tank and check the pressure reading on the manometer and adjust as needed.
(Minimum 12" WC & Maximum 14" WC)
- Rotate the white plastic regulator adjustment screw clockwise to increase the pressure or counterclockwise to decrease the pressure.
- Replace the regulator adjustment screw cap.
- Close the valve on the propane tank and remove the manometer. Replace the inlet pressure tap plug. (Use thread sealant on the tap plug and check for propane leaks.)

HI / LO Adjustment Screws

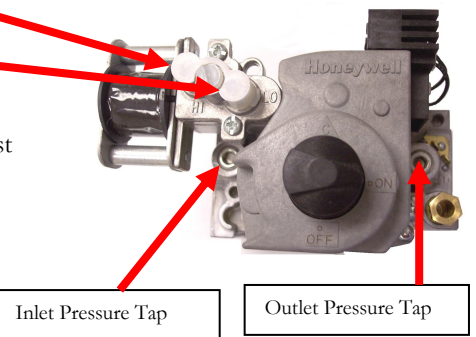

Next use the manometer to check the outlet pressure on the main gas valve. The system should be cool and solution temperature should be more than 20 degrees below the operator set point temperature.

- Remove the plug and attach a manometer to the outlet pressure tap on the main gas valve.

- i) Turn the pump switch ON and open the by-pass valve. In most cases to check the pressure you will not need to hook up any hoses or TEX units. If you need to adjust and recheck the pressure settings you may need to connect hoses and TEX units to cool the system down so you can re-heat and check both the high and low pressure settings.
- j) Open the valve on the propane tank and turn the heater switch ON.
- k) Remove the plastic cap covering the HI and LOW pressure adjustment screws.
- l) When heater is firing, check the pressure reading on the manometer. When the heater is cool, the initial firing will be the high or 2-stage mode and the pressure reading should be between 9.0" and 10.0" WC on the manometer. Adjust the HI pressure adjustment screw as needed to set the pressure at 9" - 10"WC. Rotate the HI pressure adjustment screw clockwise to increase the pressure or counterclockwise to decrease the pressure.
- m) To check the low or 1-stage mode, when the burner is firing in the High or 2-stage mode disconnect the red wire from the main gas valve and the burner will drop down to the Low or 1-stage mode. In the low or 1-stage setting the pressure should be approximately 4.9" WC. Adjust the LOW pressure adjustment screw as needed to set the pressure at 4.9"WC. Rotate the LOW pressure adjustment screw clockwise to increase the pressure or counterclockwise to decrease the pressure.
- n) Turn the heater OFF and run the pump to cool of the system.
- o) Replace the plastic cap over the HI and LOW pressure adjustment screws.
- p) Close the valve on the propane tank and remove the manometer. Replace the outlet pressure tap plug. (Use thread sealant on the tap plug and check for propane leaks.)
- q) Turn the pump OFF and disconnect the power cord.
- r) The system is ready to return to service.

2) Adjusting Pilot Flame:

If the pilot flame is small or lazy and does not touch the ground electrode, the inlet gas pressure may be too low or the pilot orifice may be partially restricted. Make sure propane tanks are full. Check the inlet gas pressure and remove pilot orifice and clean as needed before attempting to adjust the pilot flame.

If the pilot flame is hard and noisy, the inlet gas pressure may be too high. Check the inlet gas pressure before adjusting the pilot flame.

If pilot flame adjustment is necessary, proceed as flows:

- a) Connect the propane regulator and hose to the propane tank.
- b) Connect the power cord to the TES unit.
- c) Turn the pump switch ON and open the by-pass valve. You will not need to hook up any hoses or TEX units.
- d) Open the valve on the propane tank and turn the heater switch ON.
- e) Use a Phillips screw driver to remove the screw-cap covering the pilot adjusting screw.
- f) Use a flat blade screw driver to turn pilot adjusting screw clockwise to decrease the size of the pilot flame and counter-clockwise to make the flame larger.
- g) Replace the screw-cap over the pilot adjusting screw.
- h) Turn the heater OFF and run the pump to cool of the system if needed.
- i) Close the valve on the propane tank and disconnect propane regulator and hose from the tank.
- j) Turn the pump OFF and disconnect the power cord.
- k) The system is ready to return to service.

3) Pilot Assembly Removal:

- a) Close the propane tank valve and disconnect the regulator and hose from the tank.
- b) Disconnect the electrical power to the TES unit.
- c) Remove the outdoor hood assembly and front jacket panel.
- d) Disconnect the pilot gas tube from the main gas valve.
- e) Disconnect the orange igniter wire from the burner ignition control.
- f) Remove the Flame Roll-Out Shield.
- g) Remove the two screws connecting the pilot assembly to the burner drawer assembly.
- h) Remove the pilot assembly from the heater.
- i) Disconnect the pilot gas tube from the pilot assembly. Replace the pilot gas tube and compression fittings as needed.
- j) Remove the pilot orifice from the pilot assembly. Clean or replace the pilot orifice or replace the complete pilot assembly as needed.
- k) Reconnect the pilot tube to the cleaned, repaired or new pilot assembly. (Make sure the tube is installed in the same position or a new tube is bent correctly so the other end of the pilot gas tube will line up with the pilot gas outlet port on the main gas valve.)
- l) Place the pilot assembly back into the heater and secure with the two screws.
- m) Re-install the Flame Roll-Out Shield and secure with the two screws.

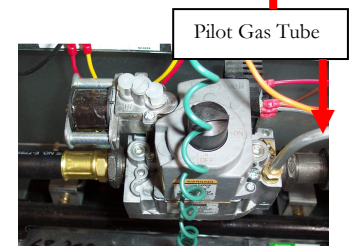
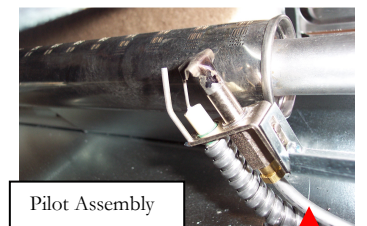
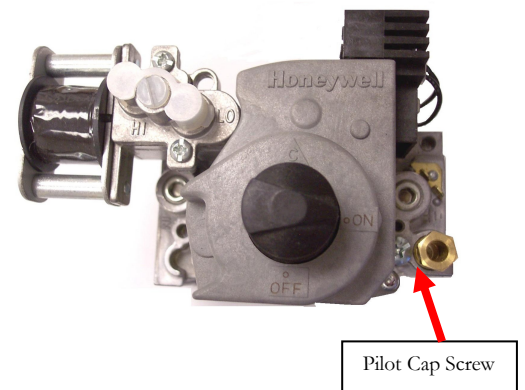

- n) Re-connect the pilot gas tube and igniter wire.
- o) Reconnect the electrical power cord. Open the valve on the propane tank and turn the pump ON.
- p) Turn the heater switch ON and check for propane leaks. Repair as needed.
- q) Turn the heater OFF. Let the pump run to cool the system as needed the turn the pump OFF.
- r) Close the valve ON the propane tank and disconnect the power cord.
- s) Re-install the outdoor hood assembly and front jacket panel.
- t) The system is ready to return to service.

4) Burner Jet Replacement:

- a) Close the propane tank valve and disconnect the regulator and hose from the tank.
- b) Disconnect the electrical power to the TES unit.
- c) Remove the four sheet metal screws and remove the outdoor hood assembly.
- d) Remove the one sheet metal screw and two screws with nuts and remove the front jacket panel.
- e) Remove the two sheet metal screws and remove the Flame Roll-Out Shield.
- f) Lift the back end of the burner tube and pull burner tube away from the first burner jet. On newer machines the back end of the burner tube may be secured with a retaining strap. On these machines you will need to remove the burner drawer. **(See Step #5)**
- g) Unscrew the first burner jet and install the new burner jet. Use thread sealant on the burner jet threads.
- h) Slip the front of the burner tube back over the burner jet and place the tab of the back end back into the slot to re-install the burner tube. (Make sure openings on the burner tube are on the top.)
- i) Repeat the procedure for the three other burner jets.
- j) Reinstall the Flame Roll-Out Shield and secure with two screws.
- k) Re-install the outdoor hood assembly and front jacket panel.
- l) The system is ready to return to service.

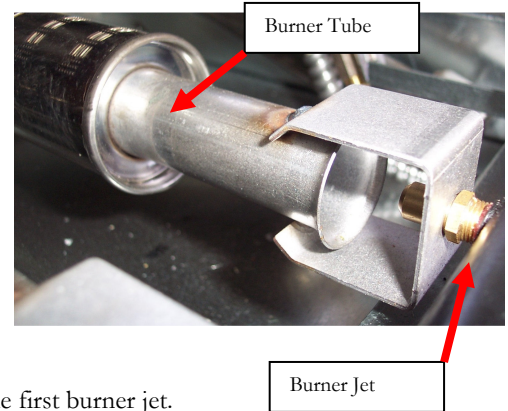

5) Burner Drawer & Burner Removal:

- a) Close the propane tank valve and disconnect the regulator and hose from the tank.
- b) Disconnect the electrical power to the TES unit.
- c) Remove the outdoor hood assembly and front jacket panel.
- d) Disconnect the propane hose from the main gas valve.
- e) Remove the Flame Roll-Out Shield.
- f) Remove the two screws that attach the burner drawer to the base panel.
- g) Disconnect the wires from the main gas valve.
- h) Pull the burner drawer out until the burners are fully exposed.
- i) Remove the burner tube retaining strap from the back end of the burner drawer and remove the burner tubes.
- j) Inspect each burner for damage or signs of deterioration. Use a brush or compressed air to remove any debris from the burner ports.
- k) Do not re-install damaged or badly corroded burners, replace them with new burners.
- l) Re-install the cleaned, repaired or new burner drawer.
- m) Reinstall the Flame Roll-Out Shield and secure with two screws.
- n) Re-connect all electrical wires to the main gas valve and the burner ignition module.
- o) Re-connect the propane hose to the main gas valve (Use thread sealant.). Reconnect the regulator and hose to the propane tank.
- p) Open the valve on the propane tank.
- q) Reconnect the power cord. Open by-pass valve and turn pump ON.
- r) Turn heater ON, check burner flame and check for propane leaks. Repair as needed. Turn heater OFF after testing and allow system to cool before turning pump OFF.
- s) Close the propane tank valve and disconnect the regulator and hose from the tank.
- t) Disconnect the power cord.
- u) Re-install the outdoor hood assembly and front jacket panel.
- v) The system is ready to return to service.

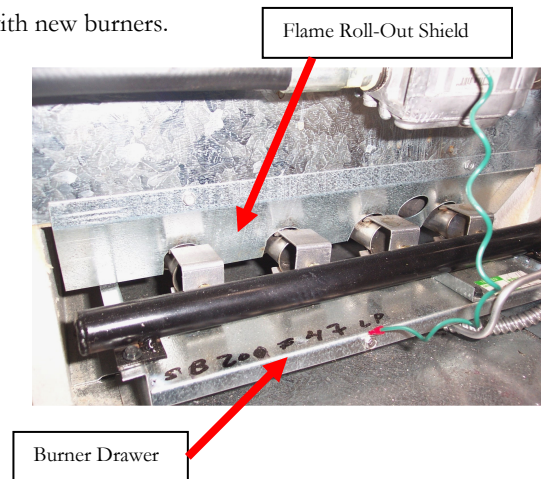

6) **Replacement of main gas valve:**

- a) Close the propane tank valve and disconnect the regulator and hose from the tank.
- b) Disconnect the electrical power to the TES unit.
- c) Remove the outdoor hood assembly and front jacket panel.
- d) Disconnect the propane hose from the main gas valve.
- e) Disconnect all electrical wires from the main gas valve.
- f) Disconnect the pilot gas tube from the main gas valve.
- g) Un-thread the gas valve from the burner assembly pipe.
- h) Thread the outlet port of the new gas valve on to the burner assembly pipe. (Use thread sealant.)
- i) Reconnect the pilot gas tube to the main gas valve.
- j) Reconnect all electrical wires to the main gas valve.
- k) Turn the knob on top of the main gas valve to the ON position.
- l) Re-connect the propane hose to the main gas valve and propane tank. Open the valve on the propane tank. Use thread sealant and check for propane leaks on the inlet side of the valve. Repair as needed.
- m) Reconnect the electrical power to the TES unit.
- n) Turn the Pump ON and open the by-pass valve. You will not need to hook up any hoses or TEX units.
- o) Turn the heater switch to the ON position and check for propane leaks on the outlet port and pilot gas tube connection. Repair as needed.
- p) Turn the heater OFF. Let the pump run to cool the system as needed the turn the pump OFF.
- q) Close the valve ON the propane tank and disconnect the regulator and hose from the tank.
- r) Disconnect the power cord from the TES unit.
- s) Re-install the outdoor hood assembly and front jacket panel.
- t) The system is ready to return to service.

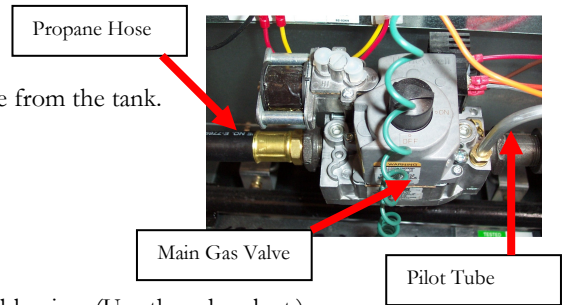

7) **Converting Gas Valve to LP:**

- a) Close the propane tank valve and disconnect the regulator and hose from the tank.
- b) Disconnect the electrical power to the TES unit.
- c) Remove the outdoor hood assembly and front jacket panel.
- d) Remove regulator cover assembly from the main gas valve.
- e) Remove the white stem and spring from the main gas valve.
- f) Insert the black stem and spring into the gas valve.
- g) Re-install the regulator cover and secure with the two screws.
- h) Place the LP Conversion Label on the main gas valve.
- i) Follow instructions to check and adjust inlet and outlet gas pressure to main gas valve.

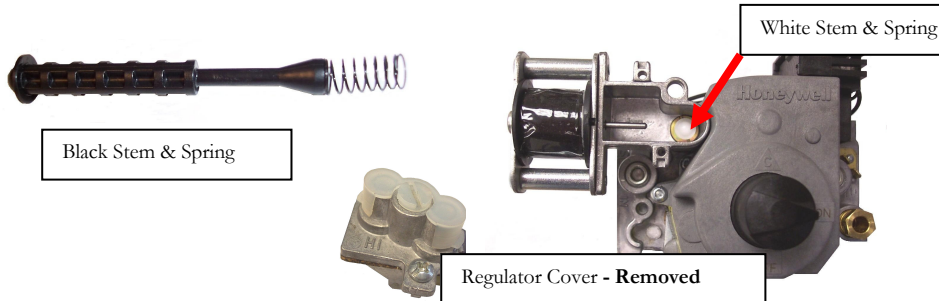
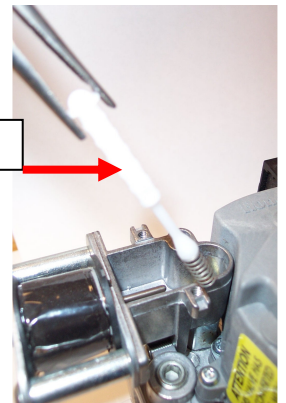
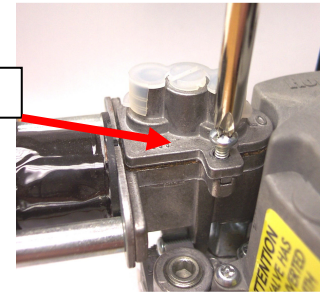

8) **Combustion Chamber Inspection:**

- a) Close the propane tank valve and disconnect the regulator and hose from the tank.
- b) Disconnect the electrical power to the TES unit.
- c) Remove the outdoor hood assembly and front jacket panel.
- d) Disconnect the propane hose from the main gas valve.
- e) Remove the Flame Roll-Out Shield.
- f) Remove the two screws that attach the burner drawer to the base panel.
- g) Disconnect the wires to the main gas valve and the burner ignition module.
- h) Pull the burner drawer out.
- i) Inspect the combustion chamber panels using a mirror and light. If any of the combustion chamber panels are damaged or show signs of deterioration, replace them. (Replacement of the combustion chamber panels requires that the heat exchanger be removed.)
- j) Re-install the burner drawer and Flame Roll-Out Shield.
- k) Re-connect all electrical wires to the main gas valve and the burner ignition module.
- l) Re-connect the propane hose to the gas valve. (Use thread sealant and check for propane leaks.)

9) Heat Exchanger Inspection & Cleaning:

- a) Close the propane tank valve and disconnect regulator and hose from the tank.
- b) Disconnect the electrical power cord to the TES unit.
- c) Relieve the system solution pressure and drain fluid. Connect a system drain hose to an outlet quick connect and direct flow into a bucket. Use an extractor or wet vacuum to remove all fluid from the TES unit.
- d) Remove the six nuts from the mounting studs on the left side header.
- e) Remove the vent cap and top jacket panel. Remove the back jacket panel and right side jacket panel.
- f) Remove the flue collector.
- g) Separate the heat exchanger tube bundle from the left side header and carefully lift the heat exchanger tube bundle out of the unit and inspect it thoroughly. Remove the V-Baffles from the heat exchanger tube bundle assembly. The outside surfaces of the copper tubes should be free of any soot deposits. A slight black smudge may be normal. Black soot indicates poor combustion. Green deposits indicate condensation due to low water return temperatures. In either case the heat exchanger must be cleaned thoroughly with water and the problem resolved before the heater is returned to service. The inside surfaces of the copper tubes should be free of any dirt or hard water deposits. A tube brush can be used to clean the inside of the heat exchanger tubes.
 - Sagging or distorted heat exchanger tubes are an indication of low water flow through the system. A damaged heat exchanger must be replaced and the cause of the damage corrected before the heater is returned to service.
- h) Re-install the right side header. When replacing the header you will probably need to replace the eight seal o-rings.
- i) Replace the heat exchanger tube bundle into the boiler and re-connect the left side header. When replacing the header you will probably need to replace the eight seal o-rings. Re-install V-Baffles on heat exchanger tube bundle assembly.
- j) Re-install the flue collector, right side jacket panel, back jacket panel, top jacket panel and vent cap.
- k) Re-fill the system with TES Thermal Fluid.
- l) Re-connect the electrical power, turn on the pump and bleed the air from the system before returning the heater to service.



Outdoor Vent Cap

10) Heater Vent System:

The outdoor vent cap must be in place during outdoor operation. If the heater is installed in a closed trailer with a ducted vent system, thoroughly inspect the vent system for any signs of blockage, corrosion or leakage before every job. Immediately replace any unsound vent system piping. This applies to exhaust vents and combustion air supply vents.

Combustion air vents must have a minimum of 100 square inches of open space near the floor and 100 square inches of open space near the roof or in roof vents. A power inlet air fan must be used to bring in cooler air, to provide adequate cooling for TES operation. Power exhaust fans should not be used. The fan should have between 600-700 cfm of air movement. Locate the fan within 12" but not less than 3" from the floor of the trailer.

Exhaust piping must be single wall galvanized metal vent pipe the same diameter of the draft flue collar (7" diameter). The trailer vent cap placed on top of the trailer, must be a wind resistant rain cap. Use the shortest, straightest vent system possible. A minimum clearance of 6" must be kept between the exhaust vent pipe and any combustible materials.



Trailer Vent Cap



Trailer Mount Exhaust

11) Propane Leaks: (Read Safety Information Section of this manual.)

Though only qualified professionals should service your propane system, there are maintenance procedures you must perform to keep your system operating safely:

- a) Check propane hoses for wear or damage every time before using heater. Replace hoses as needed.
- b) Before operating TES unit check around the heater for the smell of propane.
- c) Perform system leak test.
 1. Remove plug from Main Gas Valve Inlet pressure tap and install barb. Connect Manometer to barb.
 2. Open gas shut off valve and open propane tank valves to pressurize system.
 3. Close propane tank valves.
 4. Bleed pressure from line to reduce pressure reading on manometer by 1-2" WC. Reading on manometer should be between 9-10"WC.
 5. After 10 minutes if pressure does not drop, system is free of leaks.
 - i. If pressure drops, open propane tank valves and Check propane connections and fittings for leaks using soapy water. Tighten, re-seal or replace fittings as needed, the repeat system test until system tests OK.
 - ii. If pressure goes up, propane tank valve was not closed properly or needs to be replaced. Close or replace valve and repeat test.
- d) The outside of the propane tanks should be protected from rusting by periodic painting in a light reflective color. (White)
- e) Do not use damaged or rusted tanks. Tanks that show excessive denting, bulging, gouging or corrosion must be removed from service.

12) Controls:

There are four different styles of controls used on the TES units, two different Operator controls and two different Hi-Limit controls. All controls are wired the same and operate the same, but may not be interchangeable without modification due to differences in mounting and wire length. Identify which control you have before adjusting or ordering replacements.

- a) Check the thermostat or operating controls for proper operation. Use the heater operation section as a guide for checking the thermostat operation.
- b) Check flow switch for proper operation. Use the heater operation section as a guide for checking the flow switch operation.
- c) The aquastat high limit controls the maximum water temperature in the heater. It should be set at least 20°F above the operator control set point and no more than 30°F above the operator control set point. If the water temperature reaches the set

temperature before the demand for heat has been met, the aquastat high limit should shut the heater off. The water temperature should never exceed the maximum set point of 230°F. The aquastat high limit cannot be repaired. If it fails to function properly it must be replaced.



Honeywell Control
PR14187 Old Style Operator Control
PR0102 New Style Hi-Limit Control



PR14117 Old Style Hi-Limit Control

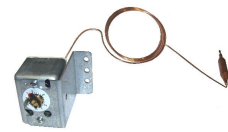

PR1417A New Style Operator Control

13) Pressure Relief Safety Valve:

The pressure relief valve should not weep or discharge water at normal system pressures. If it does, perform a “try lever test”. Even if the valve is not leaking, a “try lever test” should be performed once every two months to flush debris from valve and fittings. Before performing the test place a container under the discharge hose port on the machine base to catch fluid released during the test. With the TES unit pump ON, hold the test lever open for at least 5 seconds to flush the valve seat free of sediment and debris. Then release the lever and allow the valve to snap shut. If the lever does not activate or there is no evidence of discharge, Shut off the TES unit immediately and replace the pressure relief valve. If the valve continues to weep or discharge at normal system pressures, replace the pressure relief valve.

- Never try to clean or repair the relief valve.



Different Styles of
Pressure Relief Valves

14) Solution Filter:

Filter element should be rinsed after every job and replaced after every 200 hours of operation or sooner if heavily soiled or damaged. (Replacement element: Item #NM4319). Place container under filter. Open the valve on the bottom of the filter and drain the fluid from the filter bowl into the container. Un-screw the filter bowl from the top of the filter. Unscrew the filter retainer from top of filter and remove the old element. Rinse out filter bowl and rinse the retainer. Place the new element on the retainer and screw retainer back into the top of the filter. Re-install the filter bowl. Close the valve on the bottom of the filter bowl. The fluid which was drained from the filter can be filtered through a cloth or paper filter and poured back into the fluid reservoir.



Solution Filter

15) Spiro-vent:

The Spiro-vent removes air from the solution system. Other than periodic rinsing of the check valve assembly, little maintenance is required. A small amount of fluid coming out of the vent is normal. Continuing fluid flow may indicate that the internal check valve is being held open by debris. The Spiro-vent can be disassembled, cleaned or replaced as needed.

To clean Spiro-vent:

- a) Remove the vent hose from barb on Spiro-Vent.
- b) Hold Body of Spiro-Vent with one pipe wrench while you use a second pipe wrench to loosen the top section and remove it from the Spiro-Vent body.
- c) Remove the metal plate from the bottom of the top section.
- d) Rinse out the top section and check float operation. Remove floats and clean valve seats as needed. Then replace the metal plate.
- e) Pull screen out of Spiro-Vent body and rinse screen before replacing. Replace screen if damaged. Replacement stainless steel screen is part number NM4205A.
- f) Thread the top section back onto the Spiro-Vent body and tighten using the two pipe wrenches.
- g) Reconnect the vent hose to the barb and tighten the hose clamp.



Spiro-vent

16) Expansion Tank:

The expansion tank absorbs pulsations and pressure spikes in the solution system. Check bladder pressure and re-pressurize as needed to maintain 12psi.

Over-charging the expansion tank may cause the pressure relief safety valve to open and discharge fluid. If pressure continuously leaks or bladder is ruptured, replace the expansion tank with new tank set at 12psi bladder pressure.



Expansion Tank

17) Solution Reservoir:

Holds a supply of TES Thermal Fluid to be added to the closed loop solution system that may leak during the connecting and disconnecting of the hoses and heat exchangers or to replace the volume of air removed by the Spiro-Vent with liquid to maintain the system level and maintain flow and pressure. The System Pressure Pump draws the solution from the tank and pumps it into the system as needed. Add TES Thermal Fluid as needed to maintain the fluid level above the 1/2 full point in the reservoir. Keep lid on tank during storage and operation to keep debris or other contamination out of tank. Check and clean filter screen and remove debris from tank as needed. Remove and dispose contaminated fluid.

18) Solution Pump:

The solution pump provides the solution flow and pressure for the heater system. The solution pump requires no periodic maintenance.

The closed loop system must be filled with TES Thermal Fluid and air must be removed for proper pump operation.

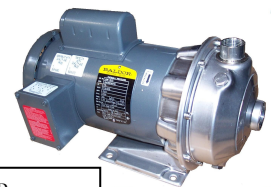

Solution Pump

To prime pump, add fluid, and remove air from system:

- a) With the pump OFF, open the by-pass valve.
- b) Make sure fluid reservoir is filled. Add TES Thermal Fluid as needed.
- c) Turn the pump ON. The System Pressure Pump will pump fluid from the reservoir into the pump inlet lines. Add TES Thermal Fluid as needed to keep the reservoir filled.
- d) Continue to run until flow becomes steady and most of the air is removed from the flow. Observe pressure gauge. Pressure will stabilize as air is removed from system. Add TES Thermal Fluid to the fluid reservoir as needed to maintain adequate fluid level.
- e) Turn the pump OFF and close the by-pass valve.
- f) Connect hoses and TEX Thermal exchangers to the TES Heater and turn pump ON. The System Pressure Pump will pump fluid from the reservoir into the solution pump inlet lines and the solution pump will pump the fluid into the hoses and TEX units. As the air is replaced by fluid in the hoses and released through the Spiro-vent add TES Thermal Fluid as needed to keep the reservoir filled.
- g) Continue to run until flow becomes steady and the air is removed from the flow. Observe pressure gauge. Pressure will stabilize as air is removed and system is pressurized. Add TES Thermal Fluid to the fluid reservoir as needed to maintain adequate fluid level.
- h) Turn the pump OFF and disconnect hoses and TEX Thermal Exchangers.

Solution Pump Repair:

- a) Disconnect power cord from the TES unit.
- b) Drain fluid from reservoir. Save fluid for re-use.
- c) Drain fluid from heater and fittings. Connect open 3/4" male quick connect or drain hose to outlet quick connect on the TES unit. Open by-pass valve and allow fluid to drain into a clean bucket. Save fluid for re-use. Use an extractor or wet vac to draw additional fluid out of TES unit.
- d) Remove 1" ID hose from pump outlet and remove 1-1/4" ID hose from pump inlet. Use towel to soak up any spilled fluid.
- e) Disconnect wires from junction box on side of pump motor.
- f) Remove four bolts holding pump to TES unit base and remove pump from TES unit.
- g) Remove eight casing bolts from pump. Remove casing from pump assembly.
- h) Remove guidevane and guidevane seal ring.
- i) Remove impeller locknut and remove impeller by turning counter-clockwise when looking at front of pump. Wear glove or use rag to protect hand when turning impeller. Some pumps do not have a locknut. On these pumps the impeller is secured with Loctite 243 medium strength thread locker. To remove these impellers, heat the impeller hub to 300°F to 480°F (150°C to 250°F) to decrease the break loose strength of the Loctite and unscrew the impeller from the shaft.
- j) Insert two pry bars 180° apart between the seal housing and motor adapter. The mechanical seal should come off the motor shaft with the seal housing.
- k) Push out the mechanical seal out from the motor side of the seal housing.

- l) Replace old parts with new as needed or clean old parts before re-assembly. Replace old motor with new motor if needed.
All mechanical seal components must be in good condition or leakage may result. Replacement of complete seal assembly should be considered whenever seal has been removed. A light lubricant such as glycerin can be used to ease re-assembly. Do not contaminate mechanical seal surfaces with lubricant.
- m) Inspect casing o-ring and replace as needed. Casing o-ring can be lubricated with super lube to ease assembly.
- n) Re-install impeller – turn in clockwise direction to tighten. Re-install and tighten impeller locknut. Tighten to 10ft.-lbs. of torque. **If pump has no locknut, Loctite must be used to secure impeller. Clean shaft with alcohol and let dry. Then apply Loctite 7649 primer to shaft and impeller threads and allow 3-5 minutes to dry. Next apply 3 drops of Loctite 243 to motor shaft and 2 drops to impeller threads. Tighten impeller to 144 in.-lbs. or 12ft.-lbs. Allow Loctite to cure for 30 minutes before testing or running pump.**
- o) Re-install guidevane. Inspect guidevane o-ring and replace as needed. Do not lubricate guidevane o-ring. Make sure o-ring is not pinched by impeller during re-assembly.
- p) Re-install pump casing and secure with the eight bolts. Check assembled unit for binding and correct as needed before tightening bolts. Tighten bolts in a star pattern to prevent o-ring binding.
- q) Place pump back onto TES unit base and secure with the four bolts.
- r) Reconnect wires to junction box on side of motor. Refer to wiring diagram to check wire connections.
- s) Reconnect the 1-1/4" hose to the barb on the pump inlet and reconnect the 1" hose to the barb on the pump outlet. Tighten the hose clamps.
- t) Reconnect the power cord to the plug on the TES unit.
- u) With the pump OFF, open the by-pass valve.
- v) Re-fill the fluid reservoir with TES Thermal Fluid.
- w) Turn the pump ON. The System Pressure Pump will pump fluid from the reservoir into the pump inlet lines. Add TES Thermal Fluid as needed to keep the reservoir filled.
- x) Continue to run until flow becomes steady and most of the air is removed from the flow. Observe pressure gauge. Pressure will stabilize as air is removed from system and system is pressurized. Add TES Thermal Fluid to the fluid reservoir as needed to maintain adequate fluid level. Then turn the pump OFF and close the by-pass valve. Unit is ready to return to service.

19) System Pressure Pump:

A Flojet 30psi pump is used to maintain system fluid pressure, replace lost fluid and prime the solution pump. The only required maintenance is to keep an adequate supply of TES Thermal Fluid in the reservoir and check and clean the acorn strainer in the reservoir to prevent debris from restricting the flow to the pump. If pump does not pump properly the pump can be repaired or replaced as needed.



System Pressure Pump

System Pressure Pump Removal:

- 22. Disconnect power cord from the TES unit.
- 23. Drain fluid from reservoir. Save fluid for re-use.
- 24. Remove 1/2" ID hoses from pump outlet and inlet. Use towel to soak up any spilled fluid.
- 25. Disconnect wires from pump motor and pressure switch.
- 26. Remove four bolts holding pump to TES unit base and remove pump from TES unit.

To replace Demand / Pressure Switch:

- 1. Remove screw holding cover on switch and remove cover.
- 2. Disconnect two wires from switch.
- 3. Remove two screws holding switch to pump housing and remove switch.
- 4. Remove diaphragm between pump and switch and replace with new diaphragm.
- 5. Place new switch on housing and secure with two screws.
- 6. Reconnect two wires to switch and replace cover.



Pressure Switch

To replace Valve Chamber:

- 1. Remove screw holding cover on switch and remove cover.
- 2. Disconnect two wires from switch.
- 3. Remove four screws holding pump housing onto bearing cover and remove housing.
- 4. Remove valve chamber from housing and replace with new valve chamber. Make sure o-ring is in place on top of valve chamber and properly aligned to seat inside pump housing.
- 5. Place housing and valve chamber back on top of bearing cover and secure with four screws.
- 6. Reconnect two wires to switch and replace cover.



Valve Chamber

To replace Diaphragm & Drive Assembly:

(Diaphragm & Drive Assembly includes: Diaphragm, Lower Housing / Bearing Cover, Cam and Bearing.)

1. Remove screw holding cover on switch and remove cover.
2. Disconnect two wires from switch.
3. Remove four screws holding upper pump housing onto lower housing / bearing cover and remove upper housing and valve chamber.
4. Remove two screws holding bearing cover onto motor. Rotate the lower housing / bearing cover to align drain notch with set screw on cam/bearing assembly.
5. Use 1/8" Allen wrench to loosen set screw and slide cam/bearing assembly off of motor shaft and remove the Diaphragm Drive Assembly.
6. Coat the motor shaft with grease or anti-seize lubricant.
7. Take the new Diaphragm Drive Assembly and slide the cam/bearing assembly onto the motor shaft. Position shaft so set screw is aligned with indentation on shaft and tighten set screw. Set screw must be set into indentation for proper alignment.
8. Re-install the two screws holding the bearing cover to the motor.
9. Replace valve chamber into the upper pump housing. Make sure o-ring is in place on top of valve chamber and properly aligned to seat inside the upper pump housing.
10. Place the upper housing and valve chamber back on top of lower housing assembly and secure with four screws.
11. Reconnect two wires to switch and replace cover.



To replace Pump Head:

(Pump Head includes: Upper Housing with switch, Valve Chamber and Diaphragm & Drive Assembly.)

1. Remove screw holding cover on switch and remove cover.
2. Disconnect two wires from switch.
3. Remove four screws holding upper pump housing onto lower housing / bearing cover and remove upper housing and valve chamber.
4. Remove two screws holding the lower housing assembly onto motor. Rotate bearing cover to align drain notch with set screw on cam/bearing assembly.
5. Use 1/8" Allen wrench to loosen set screw and slide cam/bearing assembly off of motor shaft and remove the lower housing assembly.
6. Coat the motor shaft with grease or anti-seize lubricant.
7. On the new pump head, remove four screws holding upper pump housing onto lower housing / bearing cover and remove upper housing and valve chamber.
8. Slide the cam/bearing assembly of the new lower housing assembly onto the motor shaft. Position shaft so set screw is aligned with indentation on shaft and tighten set screw. Set screw must be set into indentation for proper alignment.
9. Re-install the two screws holding the lower housing assembly to the motor.
10. Replace valve chamber into the upper pump housing. Make sure o-ring is in place on top of valve chamber and properly aligned to seat inside the upper pump housing.
11. Place the upper housing and valve chamber back on top of lower housing assembly and secure with four screws.
12. Remove screw holding cover on switch and remove cover.
13. Connect the two wires to switch and replace cover.



Pump Head Assembly

System Pressure Pump Replacement:

27. Place new or repaired pump back into TES unit and secure to base with four bolts.
28. Reconnect wires to the junction box on the side of the Solution Pump. Refer to the wiring diagram for the correct wire connections.
29. Reconnect the 1/2" ID hoses to pump outlet and inlet. Tighten the hose clamps.
30. Re-fill the solution reservoir with TES Thermal Fluid.
31. With the pump OFF, open the by-pass valve.
32. Turn the pump ON. The System Pressure Pump will pump fluid from the reservoir into the pump inlet lines. Add TES Thermal Fluid as needed to keep the reservoir filled.
33. Continue to run until flow becomes steady and most of the air is removed from the flow. Observe pressure gauge. Pressure will stabilize as air is removed from system and system is pressurized. Add TES Thermal Fluid to the fluid reservoir as needed to maintain adequate fluid level. Then turn the pump OFF and close the by-pass valve. Unit is ready to return to service.

20) Pressure Reducing Valve:



Sparco - Pressure Reducing Valve



Older Style - Pressure Reducing Valve



Taco - Pressure Reducing Valve

Located between the Expansion Tank and Spiro-Vent this valve is used with the System Pressure Pump to maintain the system pressure by automatically opening when fluid is required to increase system pressure. The valve is factory preset to the normal system pressure of 12psi. Due to supplier changes there are three different valves used on TES units. The older style valve and newest style Taco valves are equipped with a fast fill feature used to override the normal operation when filling and purging the system. The Sparco valve does not have the fast fill feature.

To activate the fast fill: With power cord connected to the TES unit and the Pump switch ON, push and hold in the green knob on the valve.

To adjust the system pressure (Taco Valve):

1. Place screw driver in the slot just under the fast fill cap to pop off the fast fill cap.
2. Loosen the brass screw.
3. Adjust the pressure by turning the knob. Turn the knob clockwise to increase the pressure and counter-clockwise to decrease the pressure. Turn until the indicator arrow points at desired pressure.
4. Tighten the brass screw.
5. Replace fast fill cap. Check pressure and readjust as needed

To clean the valve (Taco Valve):

1. Loosen the brass nut at the base of the knob.
2. Unscrew and remove the whole valve cartridge from the valve body.
3. Clean the cartridge in clear, cold water only and then re-install the cartridge into the valve body. This procedure will not alter the pressure setting.
4. Replace the cartridge and tighten the brass nut.

To adjust the system pressure (Older Style):

1. Use a screw driver to pop off the green cap and remove cap and spring.
2. Loosen the lock nut base of the valve.
3. Adjust the pressure by turning the screw cap. Turn the screw cap clockwise to increase the pressure and counter-clockwise to decrease the pressure.
4. Hold the screw cap while tightening the lock nut.
5. Replace spring and green cap. Check pressure and readjust as needed.

To clean the valve (Older Style):

1. Use a screw driver to pop off the green cap and remove cap and spring.
2. Unscrew the screw cap (Keep the lock nut tight.). Remove the whole valve cartridge together with the screw cap from the valve body.
3. Clean the cartridge in clear, cold water only and then re-install the cartridge into the valve body. This procedure will not alter the pressure setting.
4. Replace spring and green cap.

To adjust the system pressure (Sparco Valve):

1. Black valve knob must be turned counter-clockwise to the open position. Valve must remain open at all times during TES operation.
2. Adjust the pressure by turning the screw on shaft end opposite black valve knob. Turn the screw clockwise to increase the pressure and counter-clockwise to decrease the pressure.
3. Check the pressure. Re-adjust as needed.

To clean the valve (Sparco Valve):

1. Release pressure from the system.
2. Unscrew the valve from the body at the hex above the black valve knob. Remove the whole valve filter assembly together with the knob from the valve body.
3. Clean the valve filter assembly in clear, cold water only and then re-install the assembly into the valve body. This procedure will not alter the pressure setting.

21) Manual System Pressure Relief Valve:

The system will maintain a pressure of 12psi even after the pump is turned off. Before disconnecting any hoses the system must be cooled and the pressure relieved. Do not activate the pressure relief valve until machine has cooled. No maintenance is required.



Manual Pressure Relief Valve

22) TES & TEX Solution Hoses:

Hoses come pre-filled with TES Thermal Fluid. If hoses or quick connects leak are repaired or replaced fluid may drain out of hose and need to be replaced before returning hoses to service. See solution pump section for instructions on how to add solution and remove air from the system. Check hoses for wear and repair or replace as needed. Normal life expectancy of these hoses is 9,000 to 10,000 hours of operation. Hoses should be replaced after this level of use. Check the quick connects for dirt and wear. Clean off the quick connects and replace as needed. Do not disconnect hoses while machine is hot or pump is ON. Debris may cause quick connects to stick open. System pressure of 12psi is maintained even when pump is off. Allow the system to cool and use the manual system pressure relief valve to relieve the pressure before disconnecting hoses. Wear eye protection and leather gloves when disconnecting hoses. Wrap quick connect in a towel while disconnecting to catch released fluid. Store hoses with ends connected together to prevent leaking of fluid during storage.

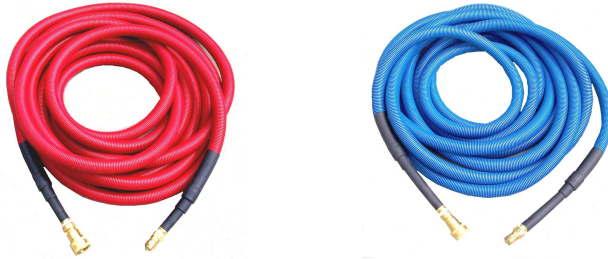

23) TEX Thermal Exchangers:

TEX Thermal Exchangers come pre-filled with TES Thermal Fluid. If coil, hoses or quick connects leak are repaired or replaced fluid may drain out of coil and need to be replaced before returning TEX Thermal Exchanger to service. See solution pump section for instructions on how to add solution and remove air from the system. Check coil and fittings for leaks. Clean coil and comb fins as needed. Clean off or replace quick connects as needed. Apply a small amount of synthetic grease with Teflon, such as Super Lube, to the o-rings in each of the female quick connects.

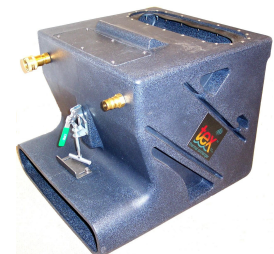

24) TES & TEX Quick Connects:

Check the quick connects for dirt and wear. Clean off quick connects and replace as needed. Apply a small amount of synthetic grease with Teflon, such as Super Lube, to the o-rings in each of the female quick connects. Wear eye protection when disconnecting hoses. Wrap quick connect in a towel while disconnecting to catch released fluid. Debris will occasionally cause quick connects to leak and system pressure may cause spraying. If quick connect leaks, press in the nipple of the quick connect to allow some liquid flow out to remove debris. If leaking cannot be stopped the quick connect should be replaced. Store hoses with ends connected together to prevent leaking of fluid during storage.

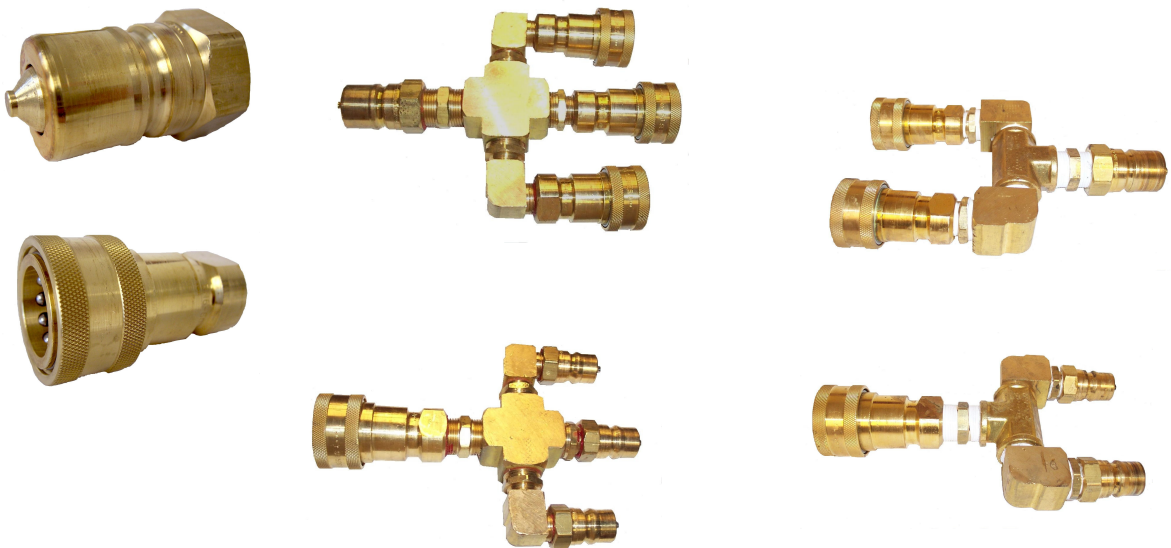

25) TES Thermal Energy Fluid:

To prevent freeze damage in freezing conditions and provide corrosion protection for the heater components TES Thermal Energy Fluid is used in this heater. The freezing point of TES Thermal Fluid is thirty degrees below zero Fahrenheit (-30°F).

The TES unit, hoses and TEX Thermal Exchangers come pre-filled with TES Thermal Energy Fluid. If fluid leaks out or is drained during repairs, the heater, pump, fittings and hoses must be re-filled with this solution and air must be removed from the system for proper operation. See the solution pump section for instructions on how to add fluid and remove air from the system.

To operate the heater a continuous flow of solution, at a flow rate high enough to activate the flow switch must be maintained.

Approximately 20 to 22 gallons of solution are required to completely fill the TES unit, hoses and TEX Thermal Exchangers.

The filter element in the solution filter should be changed after every 200 hours of operation. A complete filtering of the TES Thermal Fluid in the system should be performed after the first 300 hours of operation and every 1000 hours thereafter.

Use the TES Fluid Filter kit – **AT80 or AT84** (Kits includes extra filter cartridges)
Replacement Filter Cartridges – **NM4325A (for AT80) or NM4356A (for AT84)**

TES Thermal fluid under pressure and at high temperature can cause burns, severe personal injury or death. Do not attempt to perform filtering procedure with TES fluid temperature over 120°F.

To filter the TES fluid:

1. Turn the TES heater off and allow the TES Thermal Fluid to cool before filtering the fluid.
2. When the fluid has cooled, turn pump OFF.
3. Close by-pass valve.
4. Connect one red 3/4" TES hose to outlet quick connect on TES unit. Connect splitter, two red TEX hoses and two TEX thermal exchangers.
5. Connect filter outlet connector to one inlet quick connect of TES unit.
6. Connect one blue 3/4" TES hose to filter inlet connector. Connect splitter and two blue TEX hoses to blue TES hose. Connect the two blue TEX hoses to the two TEX thermal exchangers to complete the loop.
7. Turn pump on and run for 5 minutes.
8. Turn pump off. Disconnect the hoses and TEX thermal exchangers and connect the remaining hoses and TEX thermal exchangers the same way the others were connected and repeat the process to filter the other hoses and Tex thermal exchangers. Switch filter to other inlet quick connect and red 3/4" TES hose to the other outlet quick connect.
9. Turn pump ON and run for 5 minutes.
10. Turn pump off. Disconnect the hoses and TEX thermal exchangers. Remove and dispose filter cartridge. Replace with new clean filter cartridge.

Breakdown or dilution of the propylene glycol in the solution over time may reduce the protection ability of the TES Thermal Energy Fluid. The TES Thermal Energy Fluid should be tested periodically to determine the current concentration and level of protection. Two tests should be performed to evaluate the fluid. The first test will be to check the concentration and protection level of the fluid the second test will be to check the pH of the fluid.

To test the TES Thermal Energy Fluid, take a small fluid sample from the bottom of the Spiro-trap or by-pass filter. It could also be drained from a quick connect on the TES unit. A sample taken from the reservoir may not accurately reflect the condition of the majority of the fluid in the system. The amount of fluid needed will depend on the size and type of testers used.

A refractometer may only require a few drops. A propylene glycol tester or pH Tester may require a few ounces.

If the fluid is dirty it should be filtered before testing.

Propylene glycol coolant testers are less expensive (\$3.00 - \$20.00), but refractometers (\$100.00 - \$200.00) are much more accurate. While pH Testers can cost about \$90.00 to \$150.00 and pH test tape is only \$10.00 to \$15.00 we recommend that you use the more accurate pH Tester to check the pH of the TES Thermal Energy Fluid. Follow the testing directions for your specific tester.



TES Thermal Energy Fluid
CR01GL



AT80 – Fluid Filter Kit



AT84 – Fluid Filter Kit

Replace the TES Thermal Fluid if the protection level has dropped below the expected temperature range in your operation area or if the ph level is over 9.5 or below 7.5.



Propylene Glycol Tester



Refractometer



pH Testers



pH Test Tape

26) TES Wheels:

Check tire pressure before each job. Add air and repair tires as needed to maintain adequate air pressure. Maximum tire pressure is 50psi. You will find two grease zerks on each rigid wheel and three zerks on each swivel wheel. Use grease gun to lubricate the axles, bearings and swivel bearings in each wheel assembly as needed to maintain proper operation. Frequency of lubrication and amount of grease needed will vary with amount of use and conditions of use.

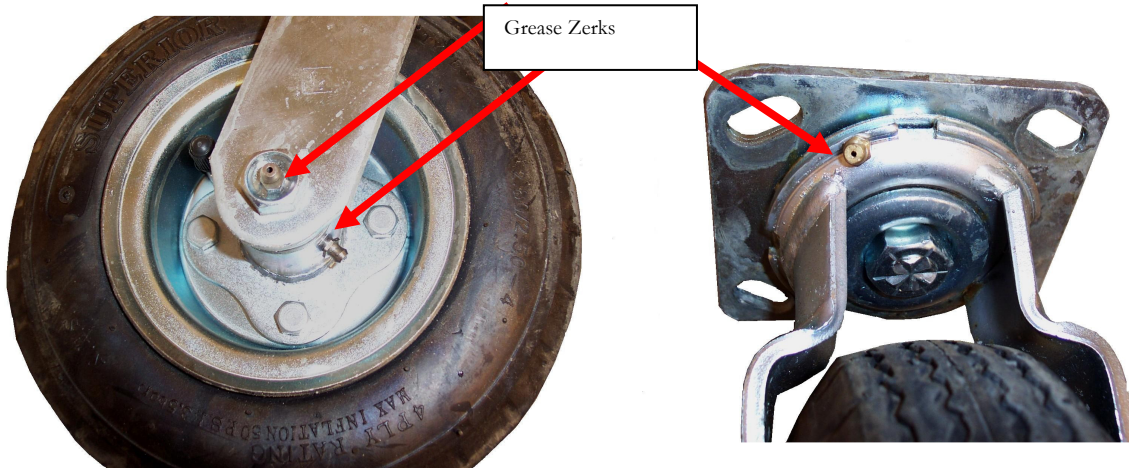

TES MAINTENANCE LOG

	MAX HRS	SERVICE	DATE & HOURS					
Daily Service should be performed before every job on which the TES unit is to be in operation. Required repairs must be completed before the unit is returned to service.								
DAILY		Check Fluid Level – Add Fluid						
DAILY		Inspect Solution Hoses						
DAILY		Inspect Propane Hoses						
DAILY		Rinse Filter Element						
DAILY		Inspect & Clean Reservoir Filter						
DAILY		Inspect TEX box heat exchanger						
DAILY		Inspect TES hoses & Hose Clamps						
DAILY		Inspect Heater Vent System						
DAILY		Inspect Combustion Chamber						
MONTHLY	100	Clean & Lubricate Quick Connects						
2 MONTHS	200	Flush Pressure Relief Safety Valve						
2 MONTHS	200	Replace Filter Element						
3 MONTHS	300	Check TES Tire Pressure						
6 MONTHS	600	Clean Spiro-vent Check Valve						
6 MONTHS	600	Tighten TEX Box Hose Clamps						
10 MONTHS	1000	Filter System Fluid						
Fluid Filtering to be done after the first 300 hours of operation and every 1000 hours thereafter. Evidence of heavy debris levels may indicate that more frequent Fluid Filtering is required.								
ANNUALLY	1200	Check Propane Gas Pressure						
ANNUALLY	1200	Check Pilot Flame						
ANNUALLY	1200	Check Propane System for Leaks						
ANNUALLY	1200	Inspect Combustion Chamber						
ANNUALLY	1200	Inspect Heat Exchangers						
ANNUALLY	1200	Inspect Burner Tubes						
ANNUALLY	1200	Inspect Heater Vent System						
ANNUALLY	1200	Clean Fluid Reservoir						
ANNUALLY	1200	Test TES Fluid						
ANNUALLY	1200	Grease Axles & Swivels on wheels						
BIANNUALLY	2400	Replace TES Fluid						
Fluid should be tested annually or every 1200 hours and replaced at that time as required by test results.								

Servicing, inspection and adjustment of the propane heater must be done by trained technicians in accordance with all applicable local and national codes.

Parts

Replacement parts available for repair of your TES Heater.

1	200,000 BTU BOILER LP/PROPANE – COMPLETE OUTDOOR USE (Includes 6 & 7)	NM4227
2	TES BASE ASSEMBLY	
3	TES WHEEL PNEUMATIC SWIVEL	NM4224
4	TES WHEEL PNEUMATIC RIGID	NM4225
5	PLATE WHEEL MOUNT - TES	NM4277
5A	PIN SNAPPER ¼" X 2" FOOT RETAINER - TES	NM4226
6	FLOW SWITCH	PR1425
7	PRESSURE RELIEF VALVE	PR30-0360
8	OUTDOOR VENT CAP	PR09-0123

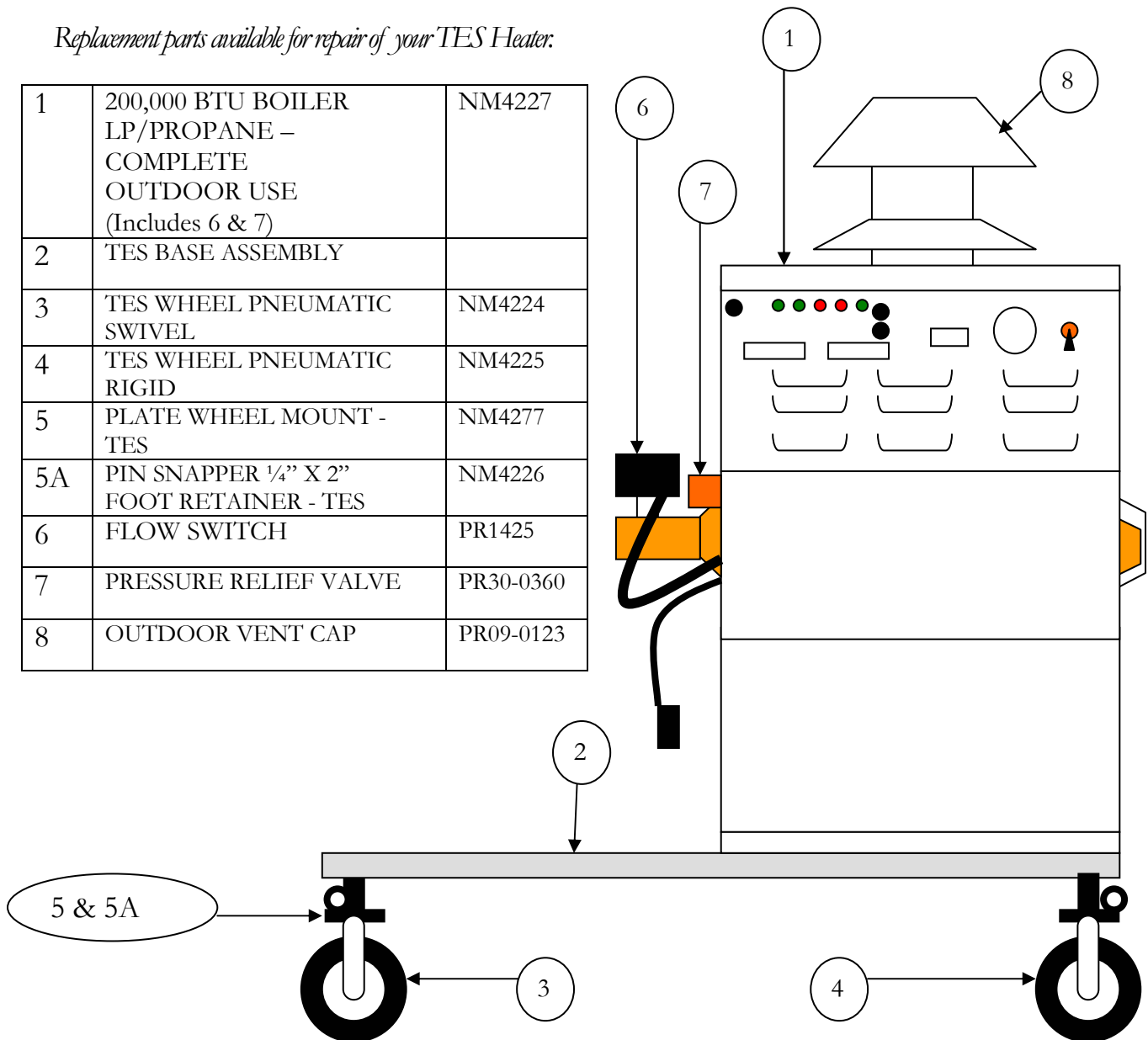

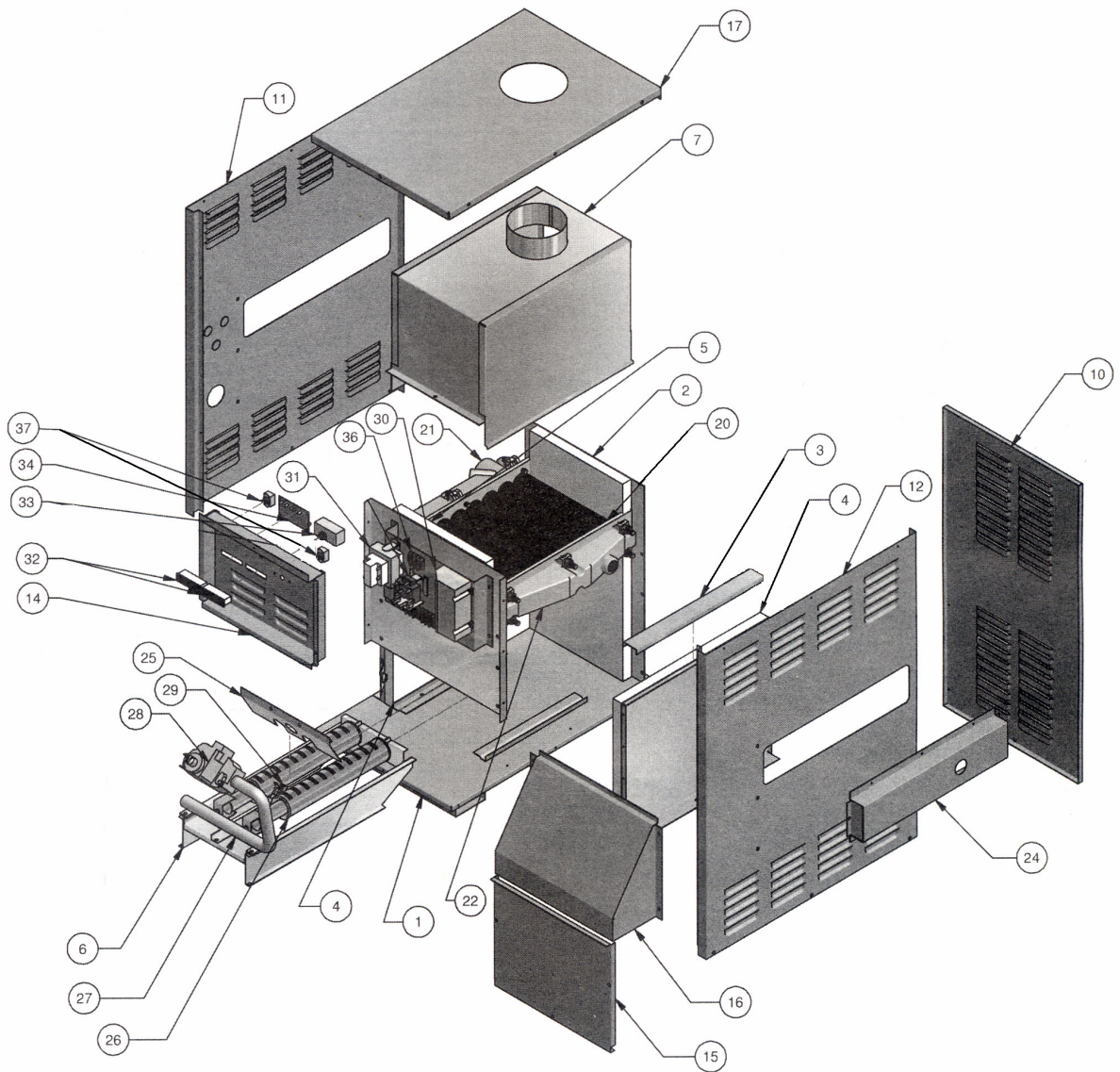
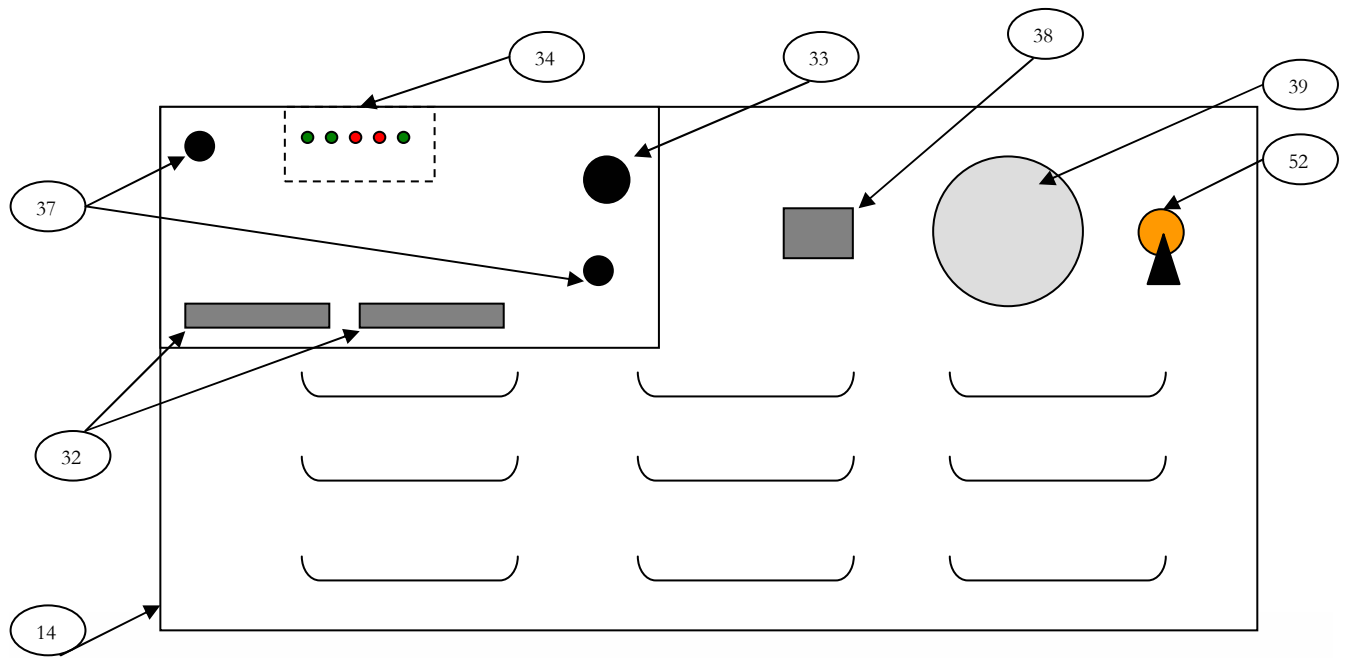

1	BASE ASSEMBLY COMBUSTION CHAMBER	70-1223		34	LIGHT PACKAGE INDICATOR LIGHTS	40-0052
2	PANEL REAR REFRACTORY	05-0037		36	TERMINAL BLOCK	48-0151
3	CHANNEL UPPER REFRACTORY	03-0884		37	TOGGLE SWITCH WITH ON / OFF PLATE	PR4810
4	PANEL SIDE REFRACTORY LEFT & RIGHT	05-0033		37	RUBBER COVER – TOGGLE SWITCH	NS160
5	PANEL FRONT REFRACTORY	05-0045		38	HOURMETER	NM4300
6	BURNER DRAWER ASSEMBLY 0-2000 FT ALTITUDE	70-1370		39	PRESSURE GAUGE 60PSI	NM4230
7	FLUE COLLECTOR	70-1258		52	MANUAL PRESSURE RELIEF VALVE	NM4316
10	PANEL REAR JACKET	03-0721				
11	PANEL LEFT JACKET	03-0774				
12	PANEL RIGHT JACKET	03-0775		NS	PRESSURE RELIEF SAFETY VALVE	PR30-0360
14	PANEL FRONT UPPER JACKET	03-0759		NS	V-BAFFLES HEAT EXCHANGERS	03-0871
15	PANEL FRONT LOWER JACKET	03-0729		NS	HEADER O-RING	PR060001
16	HOOD ASSEMBLY	70-1215		NS	VENT DAMPER 7”	09-0009
17	PANEL TOP JACKET	70-1207		NS	BURNER ORIFICE PROPANE #47 0-1999 FT	NM4295
20	TUBE BUNDLE – COPPER HEAT EXCHANGER	70-1314		NS	BURNER ORIFICE PROPANE #49 2000-3999 FT	NM4294
21	HEADER BRONZE INLET / OUTLET	01-0010-1S		NS	BURNER ORIFICE PROPANE #50 4000-5999 FT	NM4296
22	HEADER BRONZE RETURN	01-0011-1S		NS	BURNER ORIFICE PROPANE #51 6000-7999 FT	NM4298
24	COVER RETURN HEADER	03-0737		NS	GAUGE SENSOR WELL	13-0102
25	SHIELD FLAME ROLL OUT	03-0906		NS	HI-LIMIT SENSOR WELL	13-0104
26	BURNER TUBE STAINLESS STEEL	10-0251		NS	HI-LIMIT CONTROL (New Style) HONEYWELL	PR0102
27	MANIFOLD BURNER	10-0454		NS	OPERATOR CONTROL 2 STAGE – HONEYWELL (Old)	PR1417
28	MAIN GAS VALVE – LP / PROPANE - 2 STAGE	PR71579		NS	OPERATOR CONTROL 2 STAGE – JUMO (New)	PR1417A
29	PILOT ASSY – LP / PROPANE	PR709020		NS	FLOW SWITCH	PR1425
30	BURNER IGNITION CONTROL S8610M	PR16-0054		NS	HEADER STUD	57-0223
31	TRANSFORMER	PR15-0002		NS	HEADER NUT	57-0492
32	GAUGE TEMPERATURE INLET & OUTLET	PR14-0004		NS	BURNER TUBE STRAP	NM4322
33	KNOB HI-LIMIT CONTROL	14-0120		NS	BRACKET ROLL-OUT SWITCH	
NS	200°F TEMPERATURE SWITCH – FLAME ROLL-OUT	NM4404				
33	HI-LIMIT CONTROL (Old Style)	PR14117		NS	REFRACTORY PANEL KIT (Includes: #2, #4, #4 & #5)	70-1556K

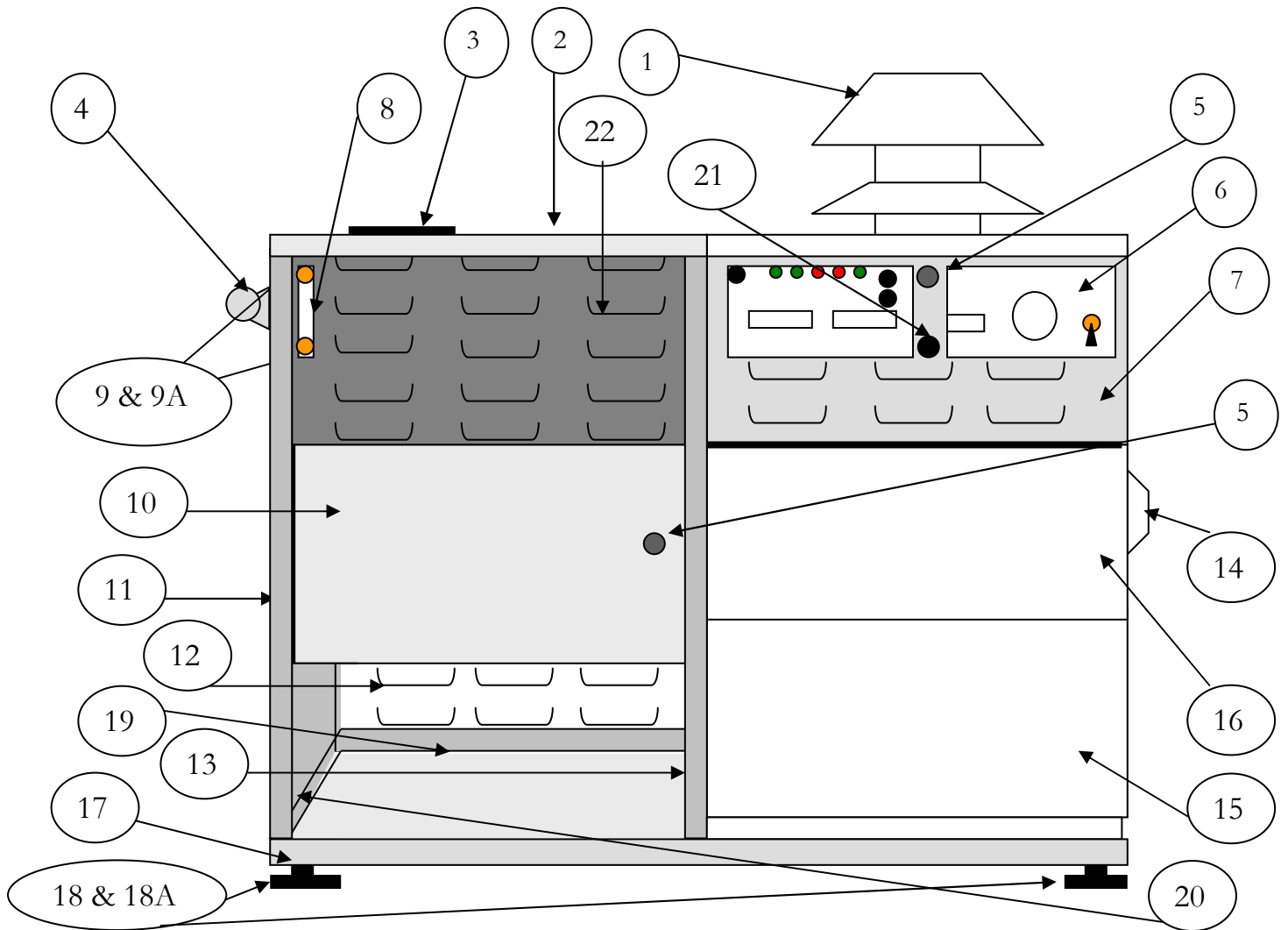

1	OUTDOOR VENT CAP	PR09-0123	15	LOWER FRONT PANEL - TES	03-0729
2	TOP COVER SS - TES	BSRBA1	16	HOOD ASSY SS - TES HEATER	70-1215
3	COVER FLUID RESERVOIR	NM5004	17	TES SS BASE COVER	BSRBA8
4	HANDLE ASSEMBLY - TES	NM4249	NS	TES BASE STEEL FRAME	
5	LATCH W/LOCK & KEY	NM4218	18	PLATE WHEEL MOUNT - TES	NM4277
6	PLEXIGLASS PANEL	NM4265	18A	PIN SNAPPER 1/4" X 2" FOOT - TES	NM4226
7	DOOR TES CONTROL PANEL	BSRBA6	19	SUPPORT BACK PANEL BASE SS	BSRBA7C
NS	HINGE CONTROL PANEL DOOR	BSRBA9A	20	SUPPORT SIDE PANEL BASE SS	BSRBA7B
8	TUBING 1/4" ID VINYL (5")	XAF1	21	KNOB PANEL DOOR	NM4271
9	ELBOW 90° 1/8" F-F BRASS	BR290	22	FRONT PANEL SS - TES	BSRBA5
9A	BARB 1/4" X 1/8" MPT BRASS	BR010	NS	WASHER PANEL KNOB - NYLON	NM4313
10	DOOR PANEL SS - HOSE ACCESS	BSRBA3	NS	SCREW 10-32 X1/2" SOCHD SS	NM4061
11	SIDE PANEL SS - TES	BSRBA4	NS	TES WHEEL PNEUMATIC RIGID	NM4225
12	BACK PANEL SS - TES	BSRBA2	NS	TES WHEEL PNEUMATIC SWIVEL	NM4224
13	SUPPORT FRONT PANEL SS	BSRBA9A	NS	TRIMLOCK - EDGE GUARD (Per inch)	NM4273
NS	FRONT SUPPORT BASE SS	BSRBA9B	NS	TES DECAL SET	NM4284
14	COVER HEADER SS - TES	03-0737	NS	TANK FLUID RESERVOIR - TES	NM4275

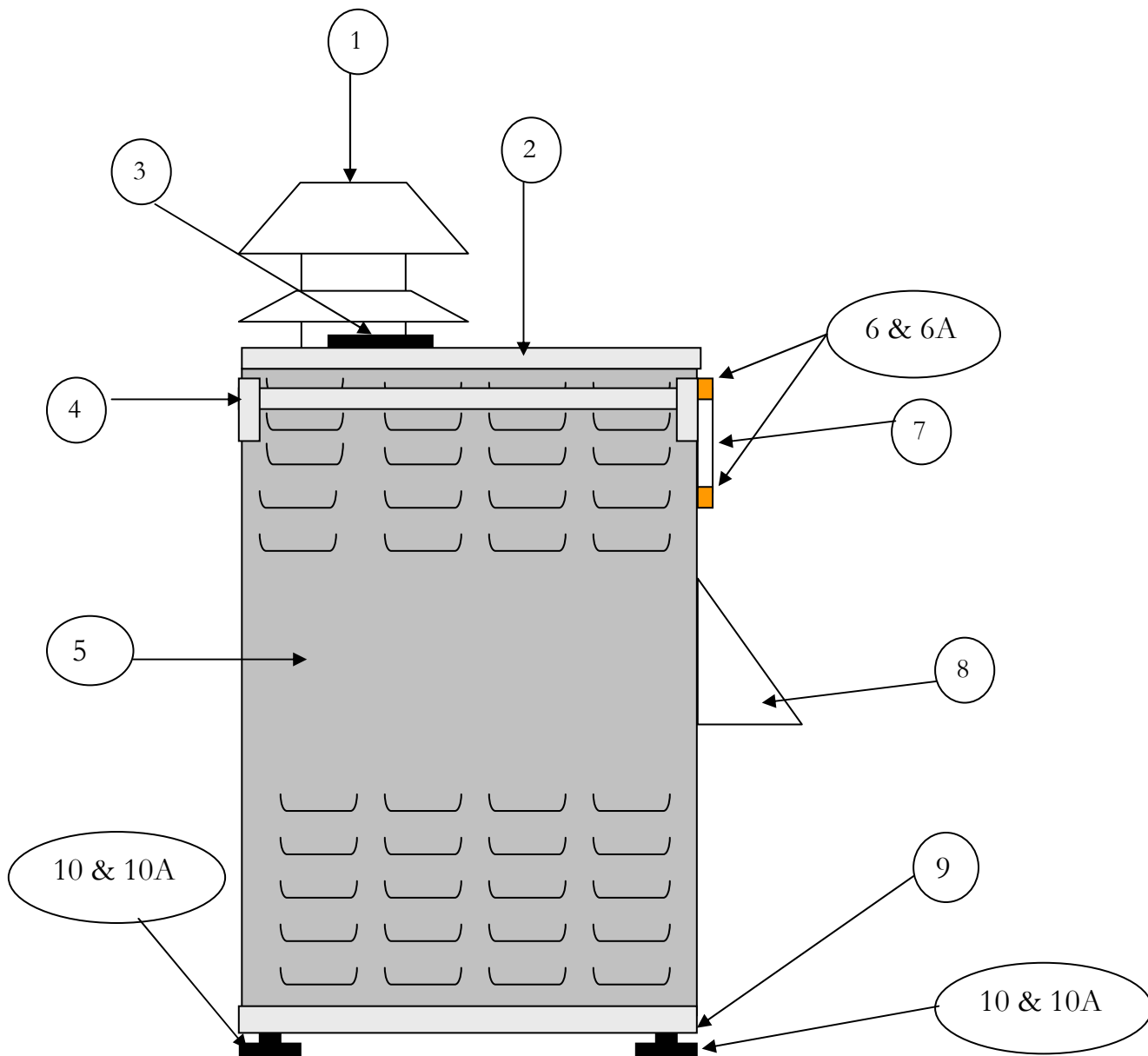

1	OUTDOOR VENT CAP	PR09-0123		10	PLATE WHEEL MOUNT - TES	NM4277
2	TOP COVER SS - TES	BSRBA1		10A	PIN SNAPPER ¼" X 2" FOOT RETAINER - TES	NM4226
3	COVER FLUID RESERVOIR	NM5004				
4	HANDLE ASSEMBLY - TES	NM4249		NS	TES WHEEL PNEUMATIC RIGID	NM4225
5	SIDE PANEL SS - TES	BSRBA4		NS	TES WHEEL PNEUMATIC SWIVEL	NM4224
6	ELBOW 90° 1/8" F-F BRASS	BR290		NS	WHEEL KIT - TES	AT52
6A	BARB ¼" X 1/8" MPT BRASS	BR010		NS	TES DECAL SET	NM4284
7	TUBING ¼" ID VINYL (5')	XAF1		NS	FLUID RESERVOIR - TES	NM4275
8	HOOD ASSY SS - TES HEATER	70-1215		NS	TRIMLOCK - EDGE PROTECTOR (Sold per inch)	NM4273
9	TES SS BASE COVER	BSRBA8		NS	TES BASE STEEL FRAME	

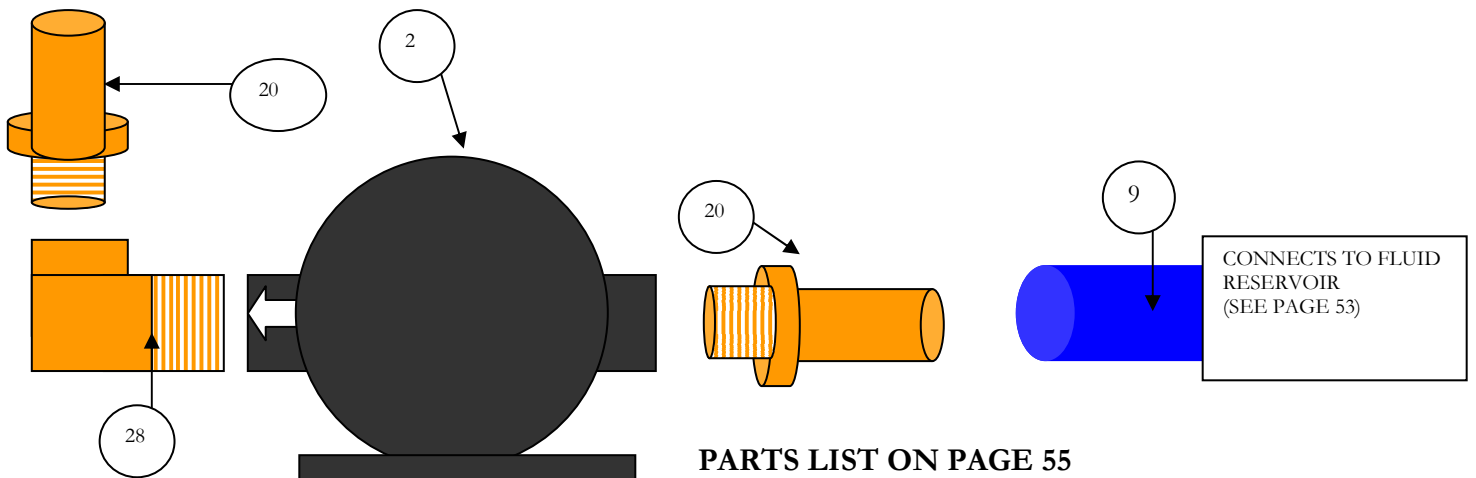
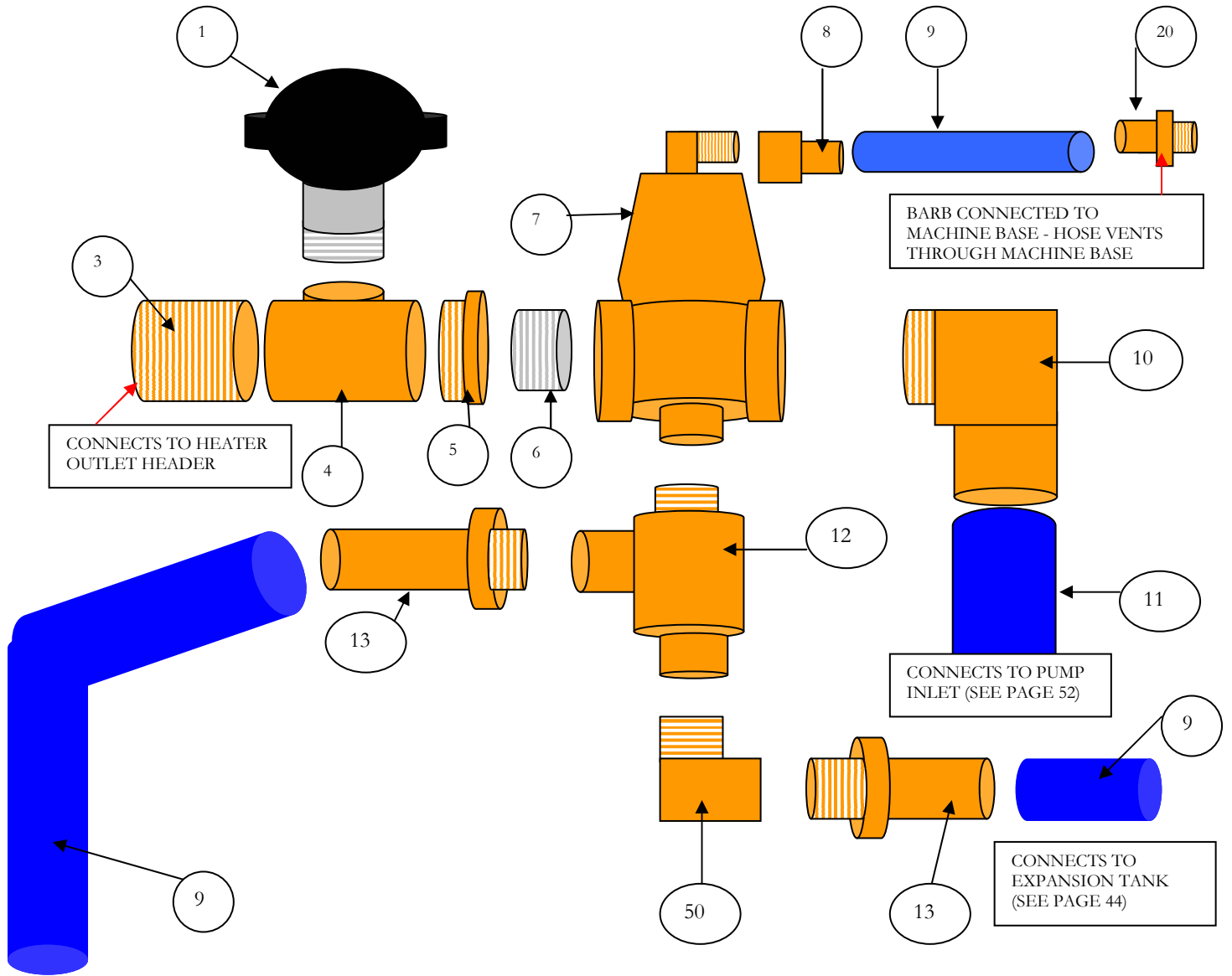

PARTS LIST ON PAGE 55

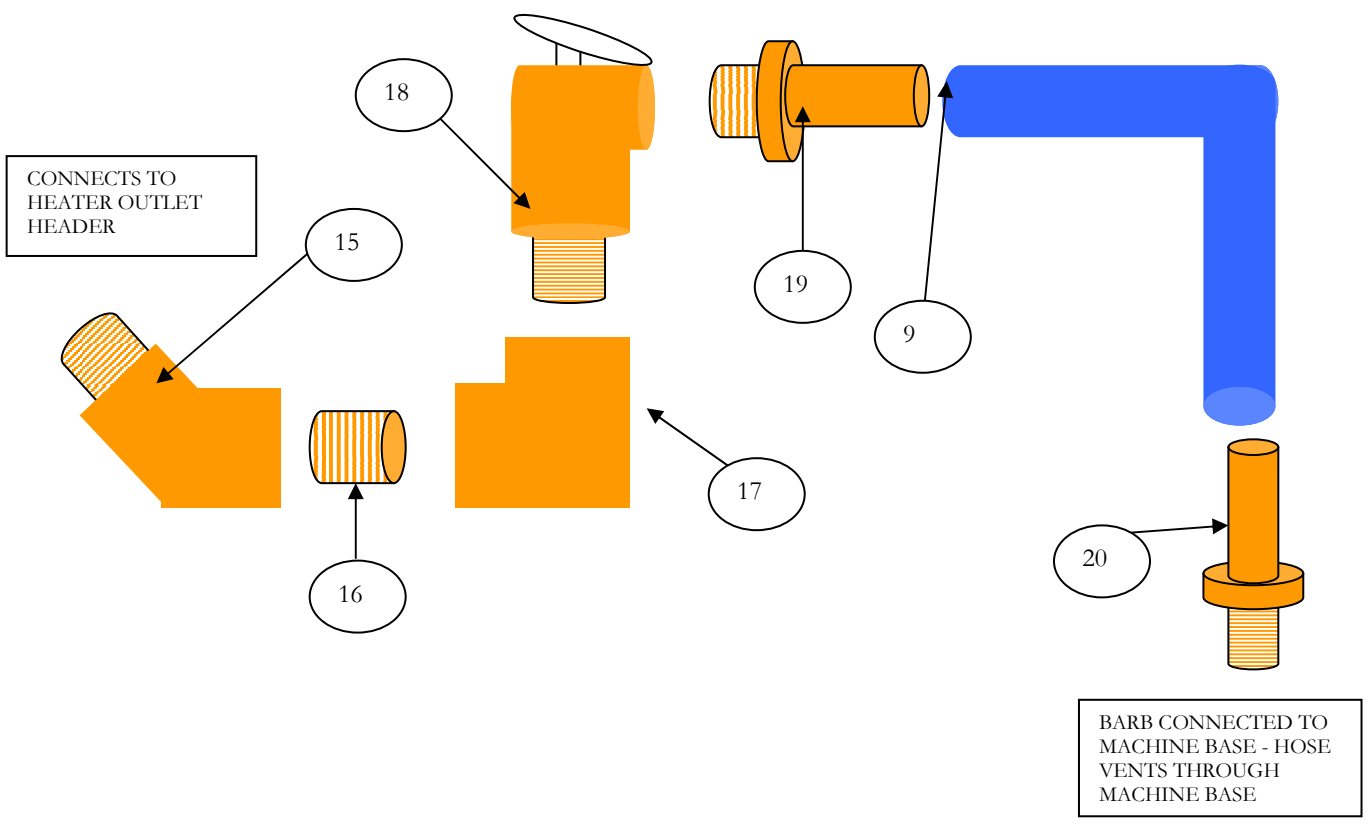
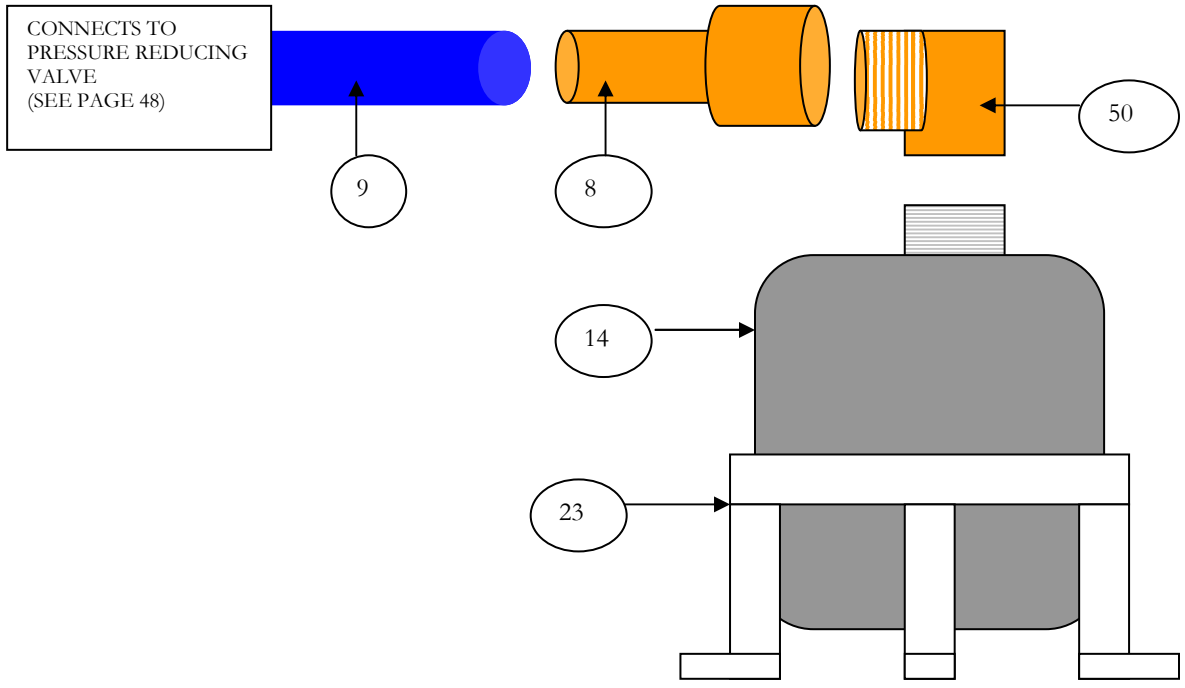

PARTS LIST ON PAGE 55

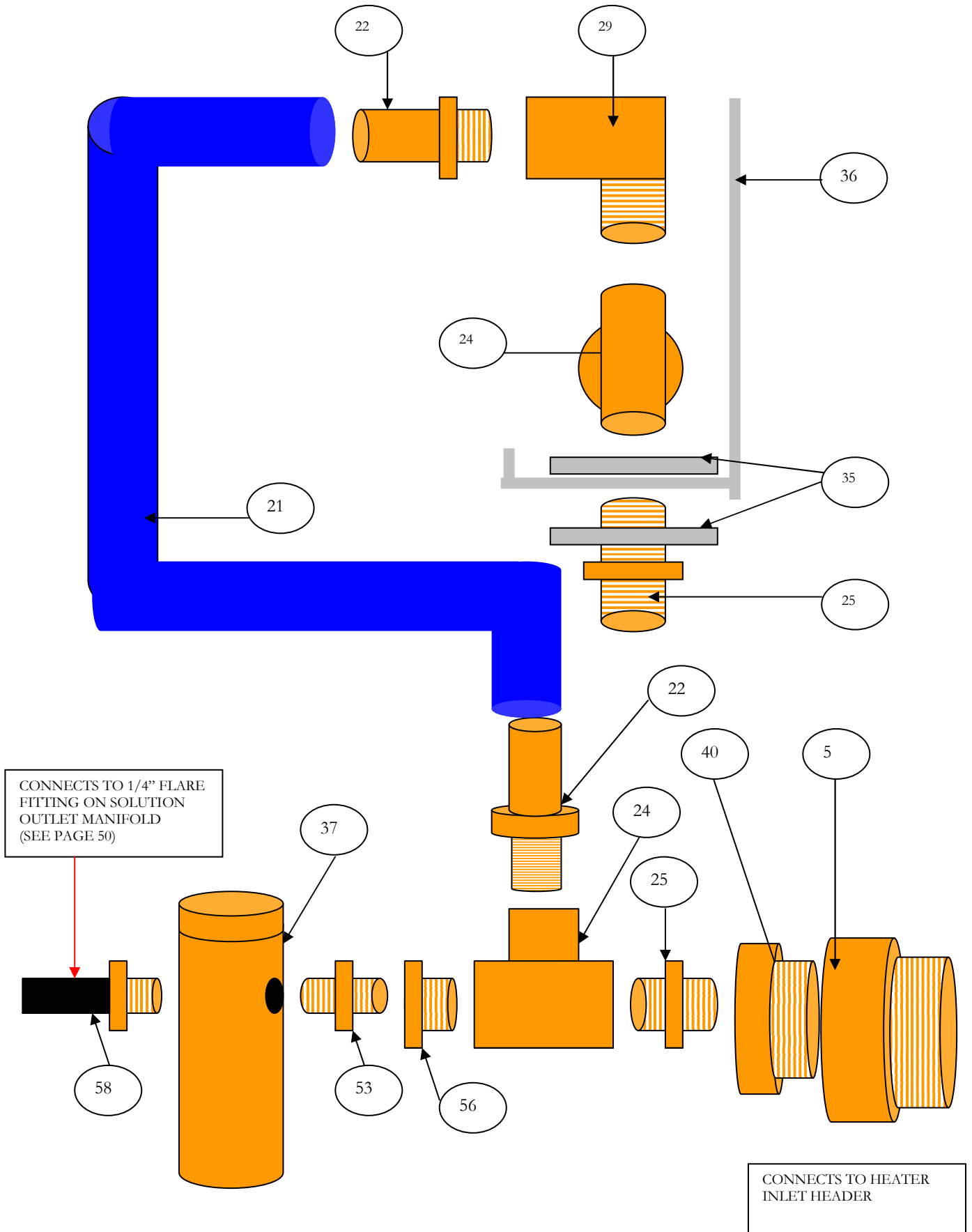

PARTS LIST ON PAGE 55

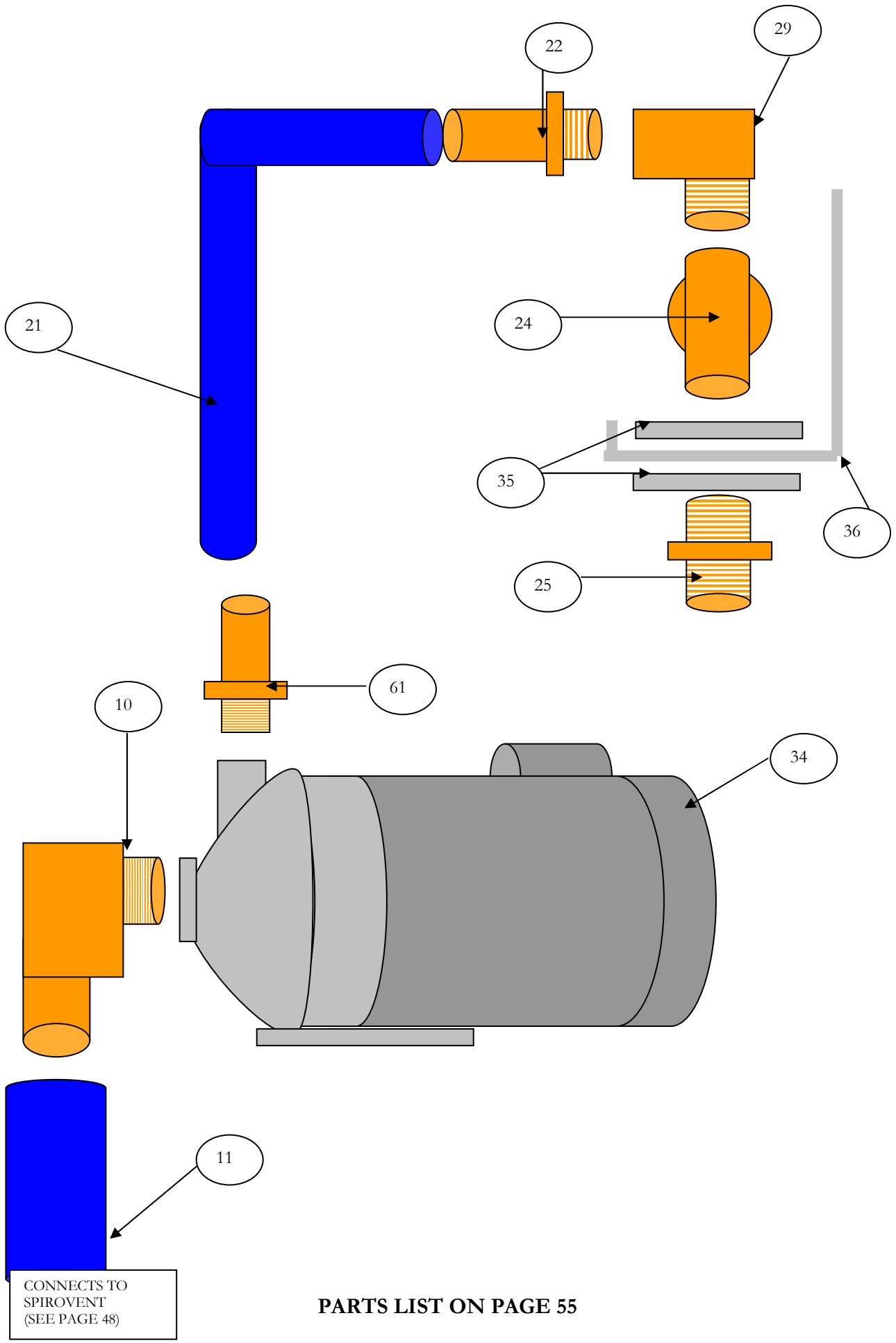

PARTS LIST ON PAGE 55

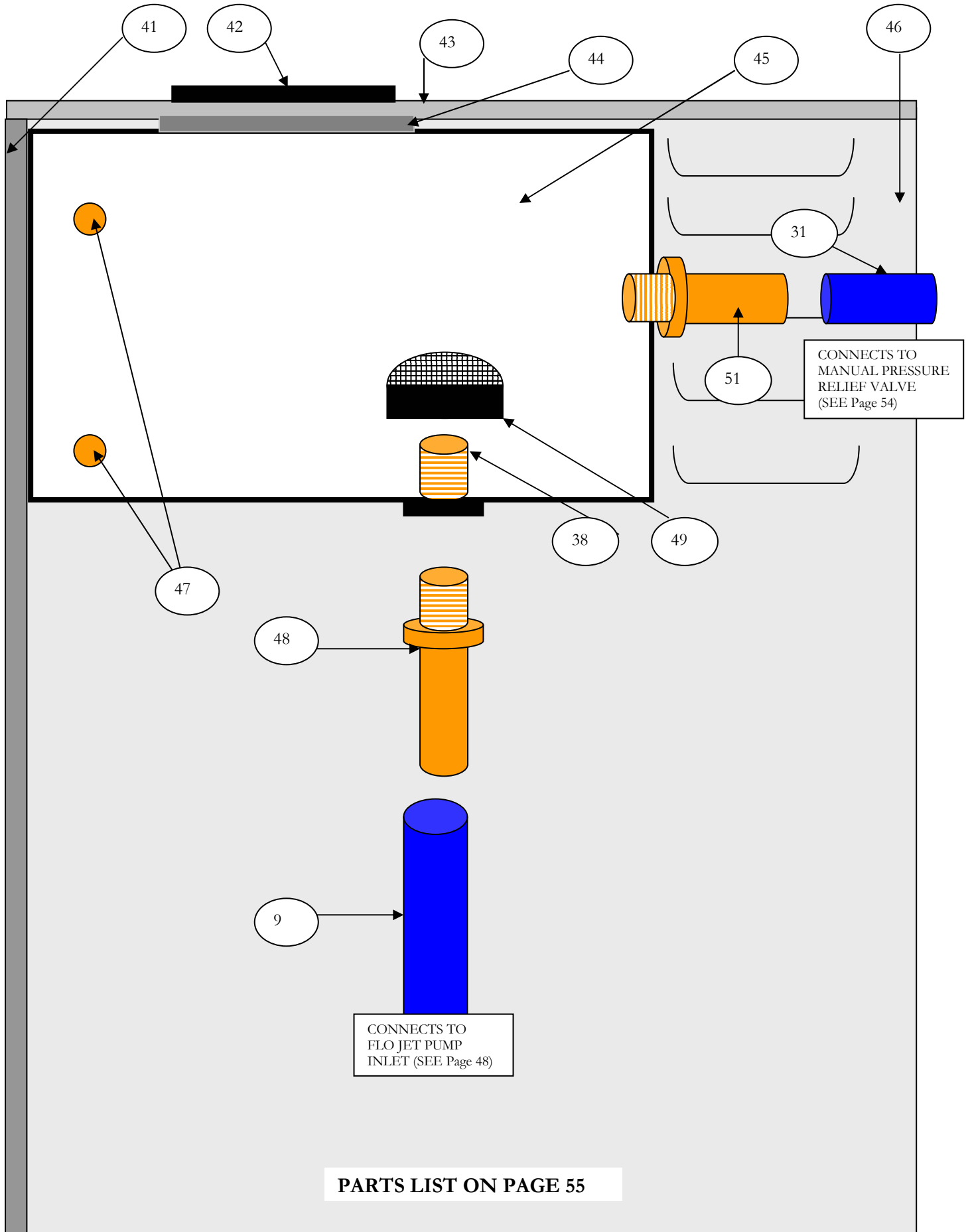

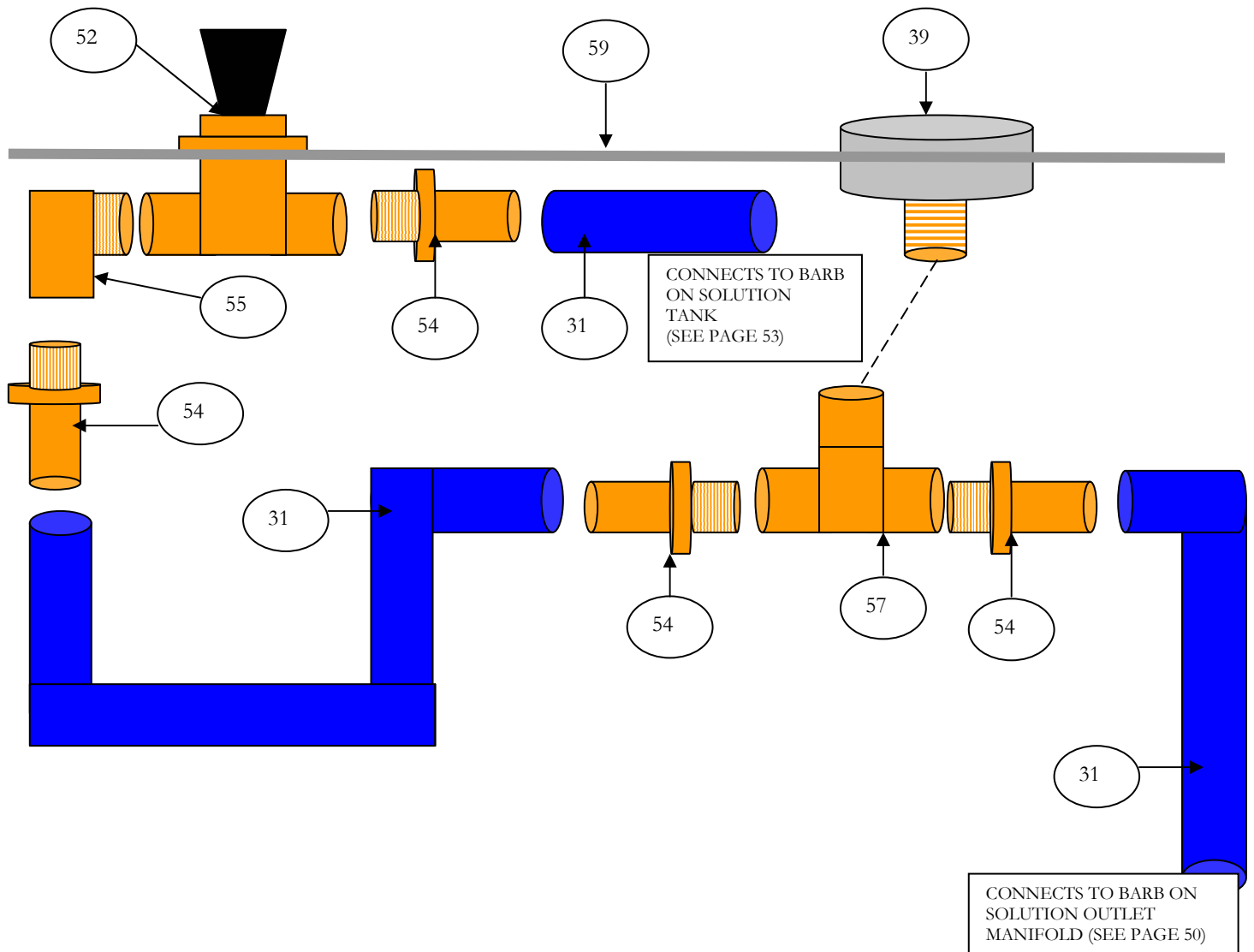

PARTS LIST ON PAGE 55

1	FLOW SWITCH	PR1425		37	FILTER ASSEMBLY 1 MICRON	NM4318
2	PUMP FLOJET 30PSI	AP23		NS	REPLACEMENT FILTER ELEMENT FOR NM4318 SOLUTION FILTER	NM4319
3	NIPPLE 1-1/2" BRASS			38	NIPPLE 1/2" CLOSE BRASS	BR086
4	TEE 1-1/2" X 1" FPT BRASS			39	PRESSURE GAUGE 0-60PSI	NM4230
5	BUSHING 1-1/2" X 1-1/4"	NM4219		40	BUSHING 1-1/4" X 3/4" BRASS	NM4222
6	NIPPLE 1-1/4" CLOSE STAINLESS STEEL	NM4220		41	PANEL SIDE SS - TES	BSRBA4
7	SPIRO-VENT	NM4205		42	COVER FLUID RESERVOIR	NM5004
8	BARB 1/2" X 1/2" FPT BRASS	BR026		43	PANEL TOP SS - TES	BSRBA1
9	HOSE 1/2" ID HI-TEMP	NM4274		44	GASKET	NM5059
10	ELBOW 90° - 1-1/4" MPT W/ 1-1/4" BARB	NM4221		45	TANK SOLUTION - TES	NM4275
11	HOSE 1-1/4" ID - PER FOOT	NM4210		46	PANEL BACK SS - TES	BSRBA2
12	VALVE PRESSURE REDUCING	NM4234		47	BARB 1/4" X 1/8" MPT BRASS	BR010
13	BARB 1/2" X 1/2" MPT BRASS	BR032		48	BARB 1/2" X 1/2" MPT BRASS - MODIFIED (NIPPLE END TAPPED 1/2" FPT)	
14	EXPANSION TANK	NM4207		49	STRAINER ACORN 1/2" FPT	PP14-806540
15	ELBOW 45° 3/4" M-F BRASS	BR278		50	ELBOW 90° 1/2" M-F BRASS	BR286
16	NIPPLE 3/4" X 2" BRASS			51	BARB 3/8" X 1/8" MPT BRASS	BR018
17	ELBOW 90° 3/4" F-F BRASS			52	MANUAL PRESSURE RELIEF VALVE	NM4316
18	PRESSURE RELIEF SAFETY VALVE	PR30-0360		53	NIPPLE 1/4" HEX BRASS	BR072
19	BARB 1/2" X 3/4" MPT BRASS	NM4214		54	BARB 3/8" X 1/4" MPT BRASS	BR020
20	BARB 1/2" X 3/8" MPT BRASS	BR030		55	ELBOW 90° - 1/4" STREET M-F	BR282
21	HOSE 1" ID HI-TEMP	NM4211		56	BUSHING 3/4" MPT X 1/4" FPT BRASS	BR203
22	BARB 1" X 3/4" MPT BRASS	BR050		57	TEE 1/4" FPT BRASS	BR242
23	CLAMP EXPANSION TANK SUPPORT	NM4269		58	HOSE ASSY HP 3/16" X 16" (1/4" MPT X 1/4" FT ENDS)	
24	TEE 3/4" FPT BRASS	BR248		59	PANEL FRONT UPPER JACKET	03-0760
25	NIPPLE 3/4" HEX BRASS	BR078		60	ELBOW 45° 1/4" FLARE X 1/8" MPT BRASS	PP12-800261
26	VALVE GATE 3/4"	NM4212		61	BARB 1" X 1" MPT BRASS	NM4209
27	TEE 3/4" FPT BRASS - MODIFIED (1/8" FPT - PRESSURE GAUGE TAP)					
28	ELBOW 90° - 3/8" STREET M-F	BR284				
29	ELBOW 90° - 3/4" STREET M-F	BR288		NS	GROMMET 3/4"	NM4117
30	TEE 1/8" STREET M-F-F	BR250		NS	SCREW 1/4-20 X 1" BHCS SS (10 - TANK COVER)	NM4260
31	HOSE 3/8" HI-MILER HOSE SOLD PER FOOT	NM4340		NS	NUT 1/4-20 NYLOCK SS (10 - TANK COVER)	NM4261
32	QUICK CONNECT 3/4" FEMALE BRASS	NM4202		NS	HOSE CLAMP 3/4" - 1-3/4" SS	PH011
33	QUICK CONNECT 3/4" MALE BRASS	NM4203		NS	HOSE CLAMP #6 MINI	NA2250
34	SS SOLUTION PUMP HI-TEMP	NM4204		NS	HOSE CLAMP 7/32" - 5/8" SS	PH05
35	WASHER 2" X 1" SS	NM4264		NS	HOSE CLAMP 9/16" - 1-1/4" SS	PH09
36	PANEL FRONT SS	BSRBA5		NS	SCREW TEK #10 X 5/8" SS	NM4263

100	CASING	1L81
101	IMPELLER	2L45
108A	MOTOR ADAPTER WITH FOOT	1L80
123	DEFLECTOR	5K7
184A	SEAL HOUSING	1L79
304	IMPELLER LOCKNUT	13K286
347	GUIDEVANE	3L23
349	SEAL RING GUIDEVANE	PG349
370	SOCKET HEAD SCREW - CASING	13L65
371	BOLTS - MOTOR	13K252
383	MECHANICAL SEAL	PG383
408	DRAIN & VENT PLUG - CASING	6L3
412B	O-RING - DRAIN PLUGS	5L99
513	O-RING - CASING	PG513

HIGH TEMP SOLUTION PUMP NM4204

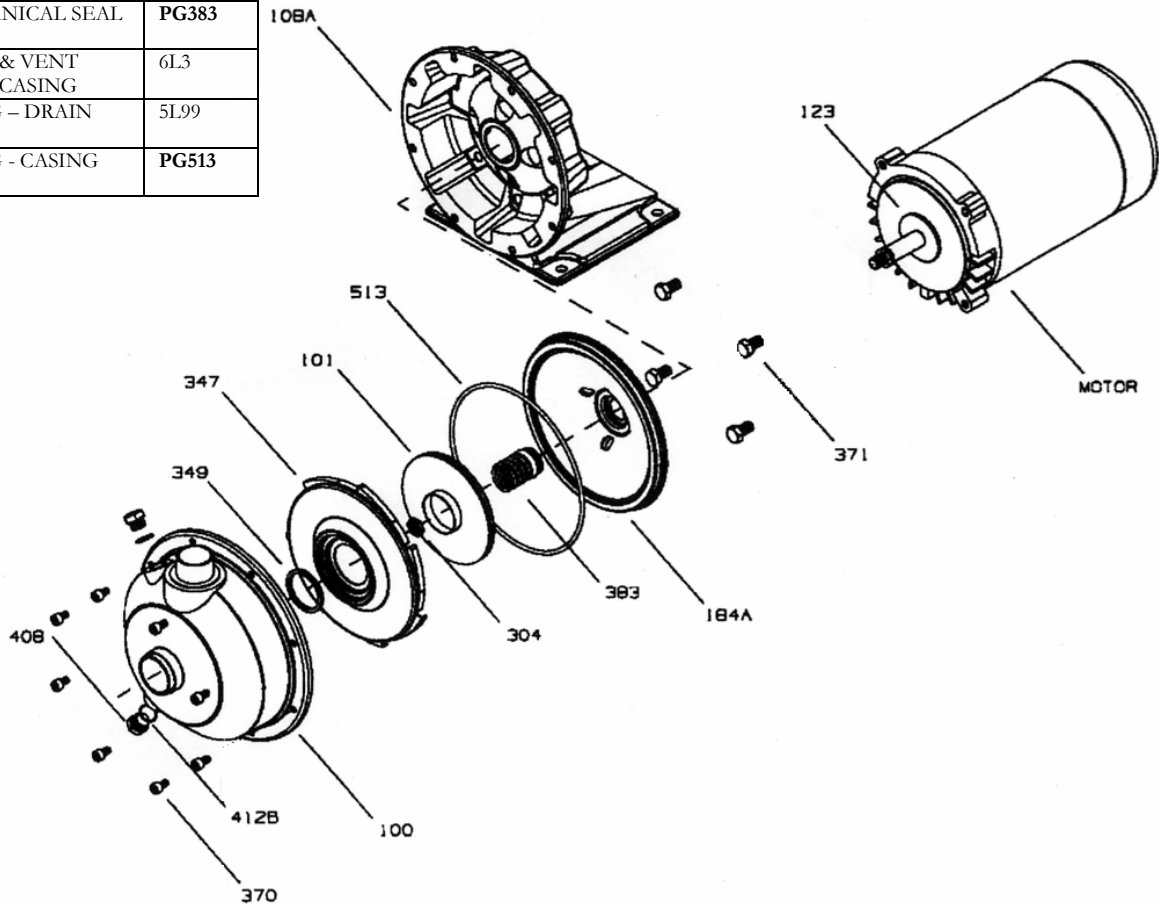

SYSTEM PRESSURE PUMP – AP23

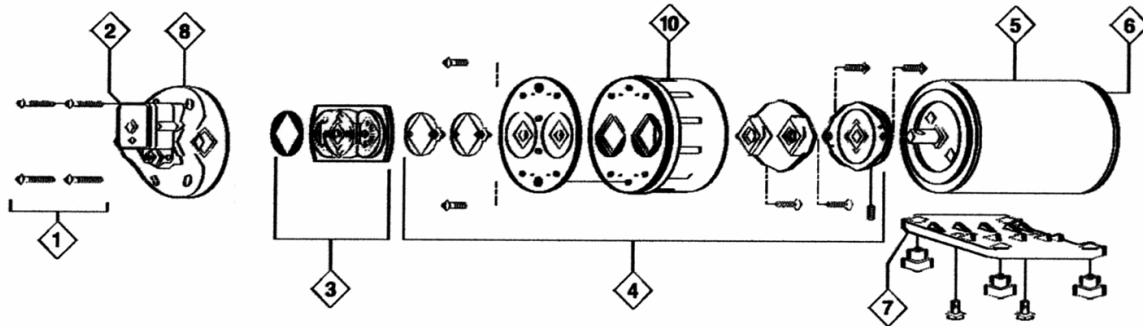

1	SCREWS PUMP HOUSING	20131-001
2	DEMAND SWITCH 30PSI	PF02090-117
3	CHECK VALVE ASSEMBLY WITH O-RING	PF20914-003A
4	KIT LOWER HOUSING DIAPHRAGM / CAM BEARING ASSEMBLY	PF21022-030A
5	MOTOR (WITHOUT BASEPLATE)	02029-000A
6	MOTOR REAR END BELL ASSEMBLY	20115-126
7	BASE PLATE & GROMMETS	11028-101
8	UPPER HOUSING WITH SWITCH	PFDH21E301

PRESSURE REDUCING VALVE (Taco Valve) NM4234



→ PUSH KNOB TO ACTIVATE FAST FILL

Replacement Parts

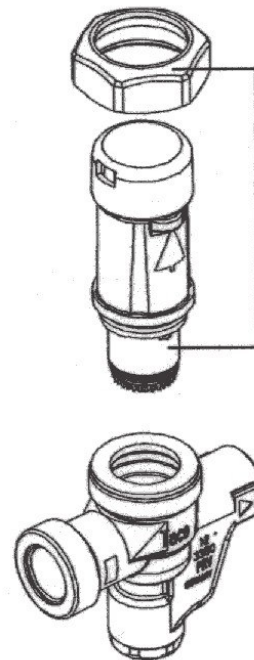

Cartridge Assembly
Part No.:
3350-004 RP

PRESSURE REDUCING VALVE (Sparco Valve) NM4234

VALVE MUST BE IN OPEN POSITION AT ALL TIMES DURING TES OPERATION

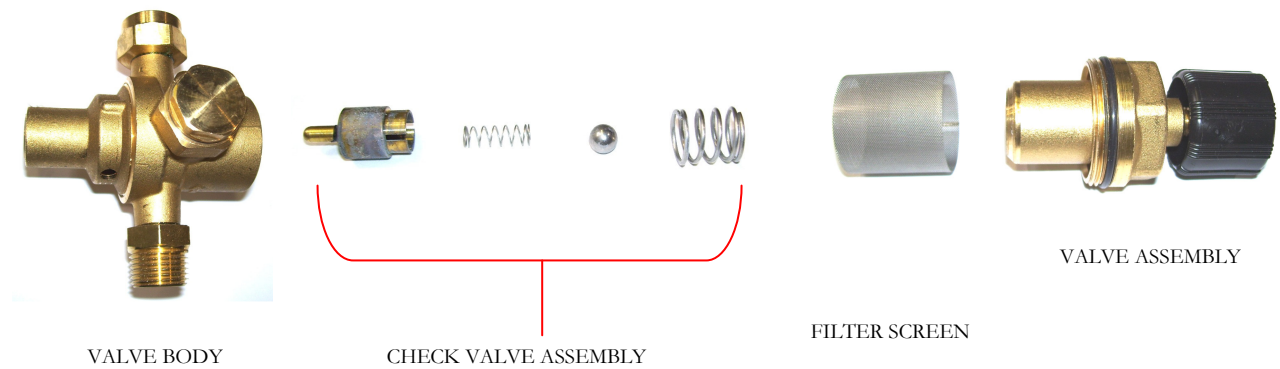

THIS VALVE DOES NOT HAVE FAST FILL FEATURE

PRESSURE ADJUSTING SCREW

- TURN CLOCKWISE TO LOWER PRESSURE
- TURN COUNTER-CLOCKWISE TO INCREASE PRESSURE

PRESSURE REDUCING VALVE (Old Style) NM4234

Replacement Parts

PUSH KNOB TO ACTIVATE FAST FILL

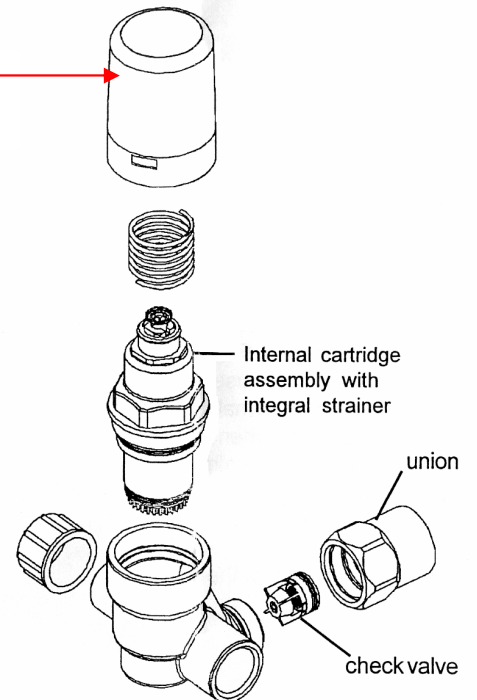
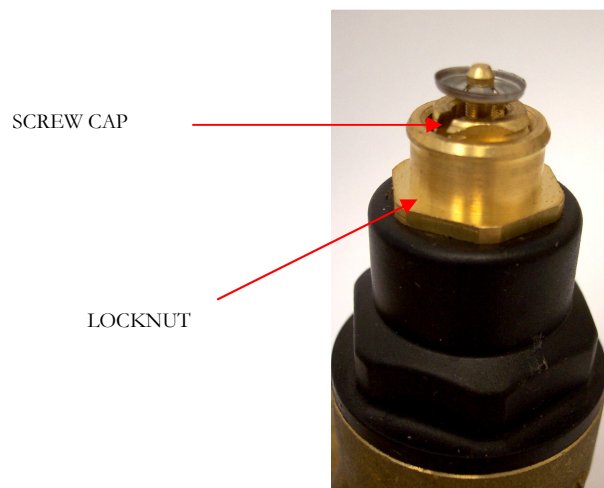

TES THERMAL EXCHANGER – MB212

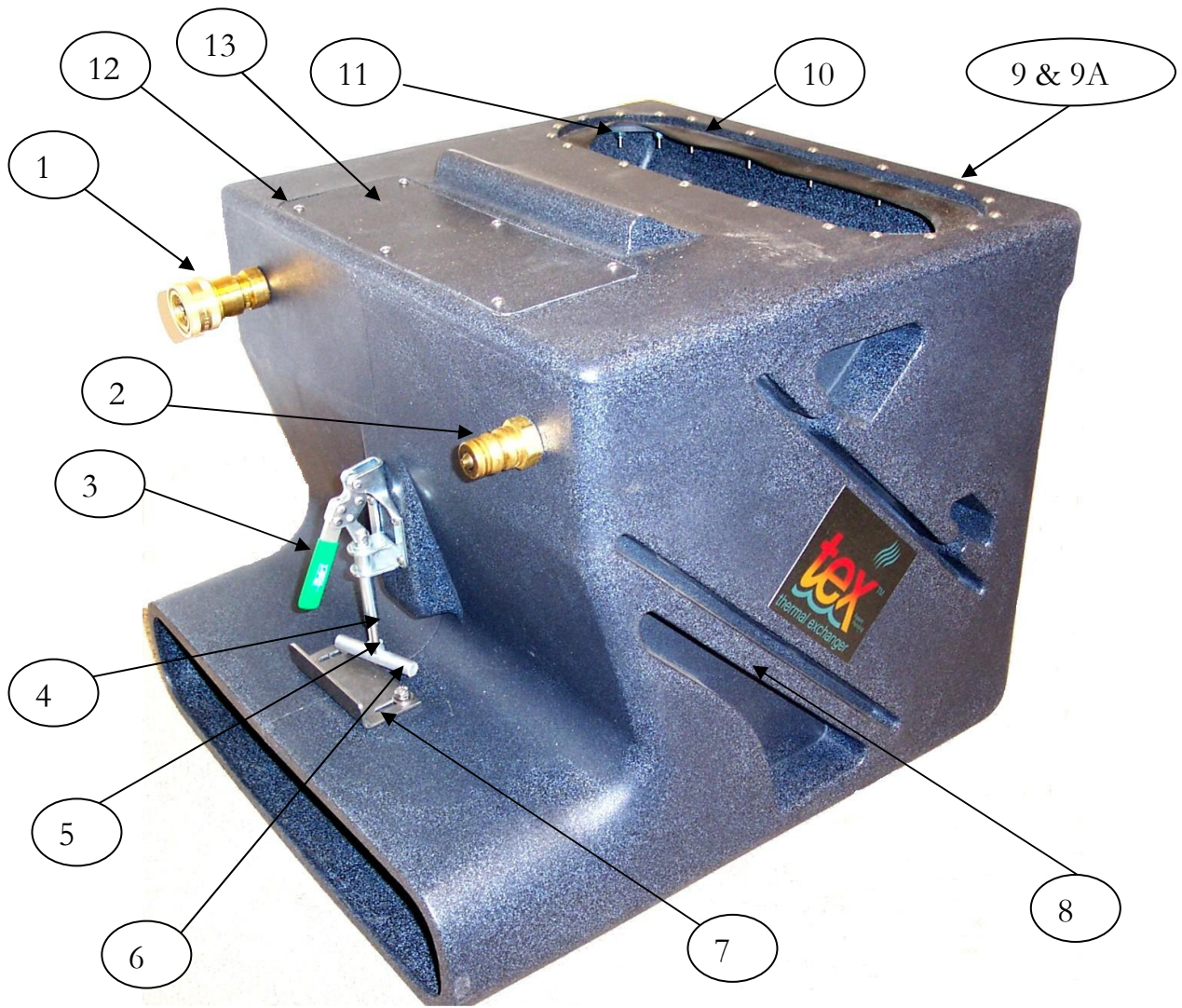

1	QUICK CONNECT 1/2" FEMALE BRASS	NM4200	11	RETAINER PLATE - GASKET	NM4241
2	QUICK CONNECT 1/2" MALE BRASS	NM4201	12	SCREW 10-32 X 3/8" PH SS	
3	CLAMP TOGGLE	NM4245	10	GASKET SILICONE RUBBER	NM4238
4	STUD 5/16-18 X 2"	NM4246	13	COVER PLATE - TEX	
5	NUT 5/16-18 HEX	NM4290	NS	COIL TEX THERMAL EXCHANGER	NM4252
6	BAR CARPET CLAMP 1/2" X 3"	NM4247	NS	BRACKET SNOOT SUPPORT TEX	
7	PLATE CARPET CLAMP		NS	PLATE QUICK CONNECT SUPPORT	
8	BODY TEX THERMAL EXCHANGER - PLASTIC	NM4250	NS	ELBOW 90° 1/2" STREET M-F BRASS	BR036
9	SCREW 10-32 X 7/8" BHCS SS	NM4240	NS	BARB 5/8" X 1/2" MPT BRASS	BR286
9A	NUT 10-32 NYLOCK SS	NM4081	NS	HOSE 5/8" ID HI-TEMP	NM4237
			NS	HOSE CLAMP 9/16 - 1-1/4" SS	PH09

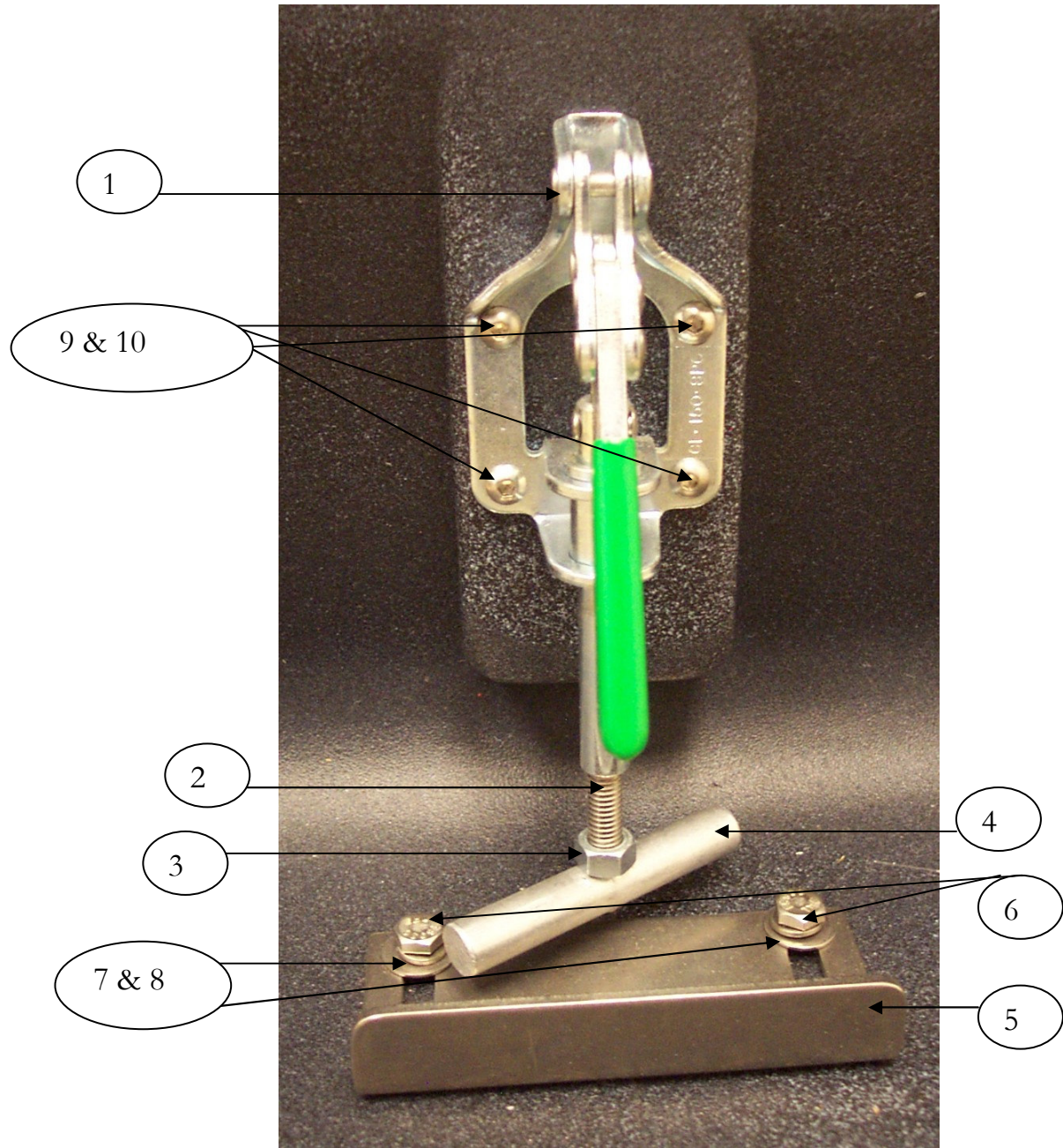

1	CLAMP TOGGLE	NM4245	7	FLAT WASHER 1/4" SS	
2	STUD 5/16-18 X 2"	NM4246	8	LOCK WASHER 1/4" SS	
3	NUT 5/16-18 HEX	NM4290	9	SCREW 10-32 X 7/8" BHCS SS	NM4240
4	BAR CARPET CLAMP 1/2" X 3"	NM4247	10	NUT 10-32 NYLOCK SS	NM4081
5	PLATE CARPET CLAMP				
6	SCREW 1/4-20 X 3/4" HXHD SS		NS	BRACKET SNOUT SUPPORT TEX	

Warranty

Your TES Thermal Energy System is designed to give you years of reliable service. If a problem should arise use the troubleshooting section in the operation manual to diagnose and correct the problem if possible. If you are unable to determine the cause or solution to the problem contact your distributor or Bridgepoint Systems for assistance.

Bridgepoint Systems warrants the heat exchanger inside the TES unit to be free from defects in material or workmanship for five years from the date of purchase.

Bridgepoint Systems warrants the roto-molded body of the TEX Thermal Exchanger to be free from defects in material or workmanship for five years from the date of purchase.

All other components of the TES Thermal Energy System are warranted to be free of defects in material and workmanship for one year from the date of purchase.

During the warranty period, Bridgepoint Systems will, at its option repair or replace components which prove to be defective.

- This warranty does not provide for replacement of complete units due to defective components.
- Service Labor is only covered for the first 90 days after the date of purchase.
- Any costs for transportation are not covered in this warranty.
- Replacement parts are warranted only for the remainder of the original warranty period.

This warranty **shall not** apply to defects resulting from improper operation, lack of maintenance, hard water deposits, condensation, chemical corrosion, unauthorized modification, misuse, abuse or exposure to freezing temperature conditions without proper propylene glycol & water solution.

This warranty **does not** cover normal wear items such as o-rings, valve seals, pump seals, hoses, quick connects, cords, tires, burner jets, or other items which require replacement as a result of ordinary usage.

To obtain warranty service for the TES Thermal Energy System, contact your distributor or Bridgepoint Systems. If the unit must be returned to Bridgepoint Systems or an authorized service center, the purchaser shall prepay shipping charges for products returned for warranty service.

- No returned items will be accepted by Bridgepoint Systems without prior authorization. All returns must have a return authorization number, issued by Bridgepoint Systems, clearly marked on the exterior of the package.

Bridgepoint Systems makes no other warranty either expressed or implied with respect to this product. The remedies provided herein are the purchaser's sole and exclusive remedies.

In no event shall Bridgepoint Systems be liable for any direct, indirect, special, incidental or consequential damages.

This warranty gives you specific legal rights. You may also have other rights which vary from jurisdiction to jurisdiction.